



Planning, Environmental &  
Development Services  
Department



Orange County Board of Zoning Adjustment

# Staff Booklet

Hearing Date:

**April 3, 2025**

Zoning Division

**ORANGE COUNTY GOVERNMENT  
BOARD OF ZONING ADJUSTMENT (BZA)**

<b><u>Board Member</u></b>	<b><u>District</u></b>
Thomas Moses (Vice Chair)	1
John Drago (Chair)	2
Juan Velez	3
Glenn Rubinstein	4
Johnny Stanley	5
Sonya Shakespeare	6
Roberta Walton Johnson	At Large

**BZA Staff**

Laekin O'Hara	Chief Planner
Jenale Garnett	Planner II
Catherine Glase	Planner I

The notated public hearing is quasi-judicial in nature. As such, any verbal or written communication with a member of the Board of Zoning Adjustment prior to today's quasi-judicial hearing should be disclosed on the record or made a part of the record during the public hearing by or on behalf of the party who communicated with the Board member to allow any interested party an opportunity to inquire about or respond to such communication. Failure to disclose any such communication may place the party who ultimately prevails at the quasi-judicial hearing at risk of having the Board's decision overturned in a court of law due to prejudice against the party who was not privy to the ex parte communication.

# MEETING AGENDA

April 3, 2025

TIME	HEARING #	APPLICANT	DISTRICT	PAGE #
9:00 AM	SE-25-02-144	Mary Solik for Gulfstream Towers LLC	2	1
	VA-25-02-124	Chris Reed – Continued to 5/1/25	3	22
9:30 AM	VA-25-03-003	Ryan Erickson	3	23
	VA-25-04-004	Lucas Fowler	2	33
	VA-25-04-006	Louis Senneville	1	45
10:00 AM		Discussion of BZA Procedure		

**Please note that approvals granted by the BZA are not final unless no appeals are filed within 15 calendar days of the BZA's recommendation and until the Board of County Commissioner (BCC) confirms the recommendation of the BZA on Apr 22, 2025.**

# ORANGE COUNTY ZONING DISTRICTS

## Agricultural Districts

- A-1** Citrus Rural
- A-2** Farmland Rural
- A-R** Agricultural-Residential District

## Residential Districts

- R-CE** Country Estate District
- R-CE-2** Rural Residential District
- R-CE-5** Rural Country Estate Residential District
- R-1, R-1A & R-1AA** Single-Family Dwelling District
- R-1AAA & R-1AAAA** Residential Urban Districts
- R-2** Residential District
- R-3** Multiple-Family Dwelling District
- X-C** Cluster Districts (where X is the base zoning district)
- R-T** Mobile Home Park District
- R-T-1** Mobile Home Subdivision District
- R-T-2** Combination Mobile Home and Single-Family Dwelling District
- R-L-D** Residential -Low-Density District
- N-R** Neighborhood Residential

## Non-Residential Districts

- P-O** Professional Office District
- C-1** Retail Commercial District
- C-2** General Commercial District
- C-3** Wholesale Commercial District
- I-1A** Restricted Industrial District
- I-1/I-5** Restricted Industrial District
- I-2/I-3** Industrial Park District
- I-4** Industrial District

## Other District

- P-D** Planned Development District
- U-V** Urban Village District
- N-C** Neighborhood Center
- N-A-C** Neighborhood Activity Center

# SITE & BUILDING REQUIREMENTS

Orange County Code Section 38-1501. Basic Site and Principal Building Requirements

District	Min. Lot Area <sup>M</sup> (sq. ft.)	Min. Living Area/ floor area (sq. ft.)	Min. Lot width (ft.)	<sup>A</sup> Min. Front yard (ft.)	<sup>A</sup> Min. Rear yard (ft.)	<sup>A</sup> Min. Side yard (ft.)	<sup>A</sup> Min. Side street Yard (ft.)	Max. Building Height (ft.)	NHWE Setback (ft.)	Max. FAR/ Density sq. ft./ du/ac	Additional Standards
A-1	SFR 21,780 (½ acre)	850	100	35	50	10	15	35	50 <sup>A</sup>	L	
	Mobile home 2 acres	850	100	35	50	10	15	35	50 <sup>A</sup>	L	
A-2	SFR 21,780 (½ acre)	850	100	35	50	10	15	35	50 <sup>A</sup>	L	
	Mobile home 2 acres	850	100	35	50	10	15	35	50 <sup>A</sup>	L	
A-R	108,900 (2½ acres)	950	270	35	50	25	15	35	50 <sup>A</sup>	L	
R-CE	43,560 (1 acre)	1,500	130	35	50	10	15	35	50 <sup>A</sup>	L	
R-CE-2	2 acres	1,200	185	45	50	30	15	35	50 <sup>A</sup>	L	
R-CE-5	5 acres	1,200	250	50	50	45	15	35	50 <sup>A</sup>	L	
R-1AAAA	21,780(½ acre)	1,500	110	30	35	10	15	35	50 <sup>A</sup>	L	
R-1AAA	14,520 (1/3 acre)	1,500	95	30	35	10	15	35	50 <sup>A</sup>	L	
R-1AA	10,000	1,200	85	25/30 <sup>H</sup>	30/35 <sup>H</sup>	7.5	15	35	50 <sup>A</sup>	L	
R-1A	7,500	1,200	75	20/25 <sup>H</sup>	25/30 <sup>H</sup>	7.5	15	35	50 <sup>A</sup>	L	
R-1	5,000	1,000	50	20/25 <sup>H</sup>	20/25 <sup>H</sup>	5/6 <sup>H</sup>	15	35	50 <sup>A</sup>	L	
R-2	One-family dwelling, 4,500	1,000	45 <sup>C</sup>	20/25 <sup>H</sup>	20/25 <sup>H</sup>	5/6 <sup>H</sup>	15	35	50 <sup>A</sup>	L	38-456
	Two dwelling units, 8,000/9,000	500/1,000 per dwelling unit <sup>D</sup>	80/90 <sup>D</sup>	20/25 <sup>H</sup>	25	5/6 <sup>H</sup>	15	35	50 <sup>A</sup>	L	38-456
	Three dwelling units, 11,250	500 per dwelling unit	85 <sup>J</sup>	20/25 <sup>H</sup>	30	10	15	35 <sup>E</sup>	50 <sup>A</sup>	L	38-456
	Four or more dwelling units, 15,000	500 per dwelling unit	85 <sup>J</sup>	20/25 <sup>H</sup>	30	10 <sup>B</sup>	15	35 <sup>E</sup>	50 <sup>A</sup>	L	38-456; limited to 4 units per building
R-3	One-family dwelling, 4,500	1,000	45 <sup>C</sup>	20/25 <sup>H</sup>	20/25 <sup>H</sup>	5	15	35	50 <sup>A</sup>	L	38-481
	Two dwelling units, 8,000/9,000	500/1,000 per dwelling unit <sup>D</sup>	80/90 <sup>D</sup>	20/25 <sup>H</sup>	20/25 <sup>H</sup>	5/6 <sup>H</sup>	15	35	50 <sup>A</sup>	L	38-481
	Three dwelling units, 11,250	500 per dwelling unit	85 <sup>J</sup>	20/25 <sup>H</sup>	30	10	15	35 <sup>E</sup>	50 <sup>A</sup>	L	38-481
	Four or more dwelling units, 15,000	500 per dwelling unit	85 <sup>J</sup>	20/25 <sup>H</sup>	30	10 <sup>B</sup>	15	35 <sup>E</sup>	50 <sup>A</sup>	L	38-481
R-L-D	N/A	N/A	N/A	10 for side entry garage, 20 for front entry garage	15	0 to 10 <sup>S</sup>	15	35 <sup>Q</sup>	50 <sup>A</sup>	L	38-605
R-T	7 spaces per gross acre	Park size min. 5 acres	Min. mobile home size 8 ft. x 35 ft.	7.5	7.5	7.5	15	35	50 <sup>A</sup>	L	38-578
R-T-1 SFR	4,500 <sup>C</sup>	1,000	45	20	20	5	15	35	50 <sup>A</sup>	L	
Mobile Home	4,500 <sup>C</sup>	Min. mobile home size 8 ft. x 35 ft.	45	20	20	5	15	35	50 <sup>A</sup>	L	

District	Min. Lot Area <sup>M</sup> (sq. ft.)	Min. Living Area/ floor area (sq. ft.)	Min. Lot width (ft.)	<sup>A</sup> Min. Front yard (ft.)	<sup>A</sup> Min. Rear yard (ft.)	<sup>A</sup> Min. Side yard (ft.)	<sup>A</sup> Min. Side street Yard (ft.)	Max. Building Height (ft.)	NHWE Setback (ft.)	Max. FAR/ Density sq. ft./ du/ac	Additional Standards
R-T-2 (zoned prior to 1/29/73)	6,000	SFR 500 Min. mobile home size 8 ft. x 35 ft.	60	25	50	6	15	35	50 <sup>A</sup>	L	
(zoned after 1/29/73)	21,780	SFR 600 Min. mobile home size 8 ft. x 35 ft.	100	35	50	10	15	35	50 <sup>A</sup>	L	
NR	One family dwelling, 4,500	1,000	45 <sup>C</sup>	20	20	5	15	35/3 stories	50 <sup>A</sup>	L	38-1748
	Two dwelling units, 8,000	500 per dwelling unit	80	20	20	5	15	35/3 stories	50 <sup>A</sup>	L	38-1748
	Three dwelling, 11,250	1,000	45 <sup>C</sup>	20	20	5	15	35/3 stories	50 <sup>A</sup>	L	38-1748
	Four or more dwelling, units, 1,000 plus, 2,000 per dwelling unit	500 per dwelling unit	85	20	20	10	15	50/4 stories	50 <sup>A</sup>	L	38-1748
	Townhouse 1,800	750 per dwelling unit	20	25, 15 for rear entry driveway	20,15 for rear entry garage	0,10 for end units	15	40/3 stories	50 <sup>A</sup>	L	38-1748
NAC	Nonresidential and mixed use development, 6,000	500	50	0/10 maximum 60% of building frontage must conform to maximum setback	15,20 adjacent to single-family zoning district	10,0 if buildings are adjoining	15	50 feet	50 <sup>A</sup>	L	38-1741
	One family dwelling, 4,500	1,000	45 <sup>C</sup>	20	20	5	15	35/3 stories	50 <sup>A</sup>	L	38-1741
	Two dwelling units, 11,250	500 per dwelling unit	80	20	20	5	15	35/3 stories	50 <sup>A</sup>	L	38-1741
	Three dwelling, 11,250	500 per dwelling unit	85	20	20	10	15	35/3 stories	50 <sup>A</sup>	L	38-1741
	Four or more dwelling, units, 1,000 plus, 2,000 per dwelling unit	500 per dwelling unit	85	20	20	10	15	50 feet/4 stories, 65 feet with ground floor retail	50 <sup>A</sup>	L	38-1741
	Townhouse 1,800	750 per dwelling unit	20	25, 15 for rear entry driveway	20,15 for rear entry garage	0,10 for end units	15	40/3 stories	50 <sup>A</sup>	L	38-1741
NC	Nonresidential and mixed use development, 8,000	500	50	0/10 maximum 60% of building frontage must conform to maximum setback	15,20 adjacent to single-family zoning district	10,0 if buildings are adjoining	15	65 feet	50 <sup>A</sup>	L	38-1734
	One family dwelling, 4,500	1,000	45 <sup>C</sup>	20	20	5	15	35/3 stories	50 <sup>A</sup>	L	38-1734
	Two dwelling units, 8,000	500 per dwelling unit	80	20	20	5	15	35/3 stories	50 <sup>A</sup>	L	38-1734
	Three dwelling, 11,250	500 per dwelling unit	85	20	20	10	15	35/3 stories	50 <sup>A</sup>	L	38-1734

District	Min. Lot Area <sup>M</sup> (sq. ft.)	Min. Living Area/ floor area (sq. ft.)	Min. Lot width (ft.)	<sup>A</sup> Min. Front yard (ft.)	<sup>A</sup> Min. Rear yard (ft.)	<sup>A</sup> Min. Side yard (ft.)	<sup>A</sup> Min. Side street Yard (ft.)	Max. Building Height (ft.)	NHWE Setback (ft.)	Max. FAR/ Density sq. ft./ du/ac	Additional Standards
	Four or more dwelling, units, 1,000 plus, 2,000 per dwelling unit	500 per dwelling unit	85	20	20	10	15	65 Feet, 80 feet with ground floor retail	50 <sup>A</sup>	L	38-1734
	Townhouse 1,800	N/A	20	25, 15 for rear entry driveway	20,15 for rear entry garage	0,10 for end units	15	40/3 stories	50 <sup>A</sup>	L	38-1734
P-O	10,000	500	85	25	30	10 for one- and two-story bldgs., plus 2 feet for each add. story	15	35	50 <sup>A</sup>	L	38-806
C-1	6,000	500		25	20	0; or 15 ft. when abutting residential district	15	50; or 35 within 100 ft. of any residential use or district	50 <sup>A</sup>	L	38-830
C-2	8,000	500		25	15; or 25 when abutting residential district	5; or 25 when abutting residential district	15	50; or 35 within 100 ft. of any residential use or district	50 <sup>A</sup>	L	38-855
C-3	12,000	500		25	15; or 30 when abutting residential district	5; or 25 when abutting residential district	15	75; or 35 within 100 ft. of any residential use or district	50 <sup>A</sup>	L	38-880
I-1A	N/A	N/A	N/A	35	25 <sup>N</sup>	25 <sup>N</sup>	15	50; or 35 within 100 feet of any residential use or district	50 <sup>A</sup>	L	38-907
I-1/I-5	N/A	N/A	N/A	35	25, or 50 ft. when abutting residential district <sup>N</sup>	25, or 50 ft. when abutting residential district <sup>N/O</sup>	15	50; or 35 within 100 feet of any residential use or district	50 <sup>A</sup>	L	38-932
I-2/1-3	N/A	N/A	N/A	25	10, or 60 ft. when abutting residential district <sup>P</sup>	15, or 60 ft. when abutting residential district <sup>P</sup>	15	50; or 35 within 100 feet of any residential use or district	50 <sup>A</sup>	L	38-981
I-4	N/A	N/A	N/A	35	10, or 75 ft. when abutting residential district <sup>N</sup>	25, or 75 ft. when abutting residential district <sup>N</sup>	15	50; or 35 within 100 feet of any residential use or district	50 <sup>A</sup>	L	38-1008

District	Min. Lot Area <sup>M</sup> (sq. ft.)	Min. Living Area/ floor area (sq. ft.)	Min. Lot width (ft.)	<sup>A</sup> Min. Front yard (ft.)	<sup>A</sup> Min. Rear yard (ft.)	<sup>A</sup> Min. Side yard (ft.)	<sup>A</sup> Min. Side street Yard (ft.)	Max. Building Height (ft.)	NHWE Setback (ft.)	Max. FAR/ Density sq. ft./ du/ac	Additional Standards
U-R-3	Four or more dwelling units, 15,000	500 per dwelling unit	85 <sup>J</sup>	20/25 <sup>H</sup>	30	10 <sup>B</sup>	15	35	50 <sup>A</sup>	L	

**NOTE:** These requirements pertain to zoning regulations only. The lot areas and lot widths noted are based on connection to central water and wastewater. If septic tanks and/or wells are used, greater lot areas may be required. Contact the Health Department at 407-836-2600 for lot size and area requirements for use of septic tanks and/or wells.

**FOOTNOTES**

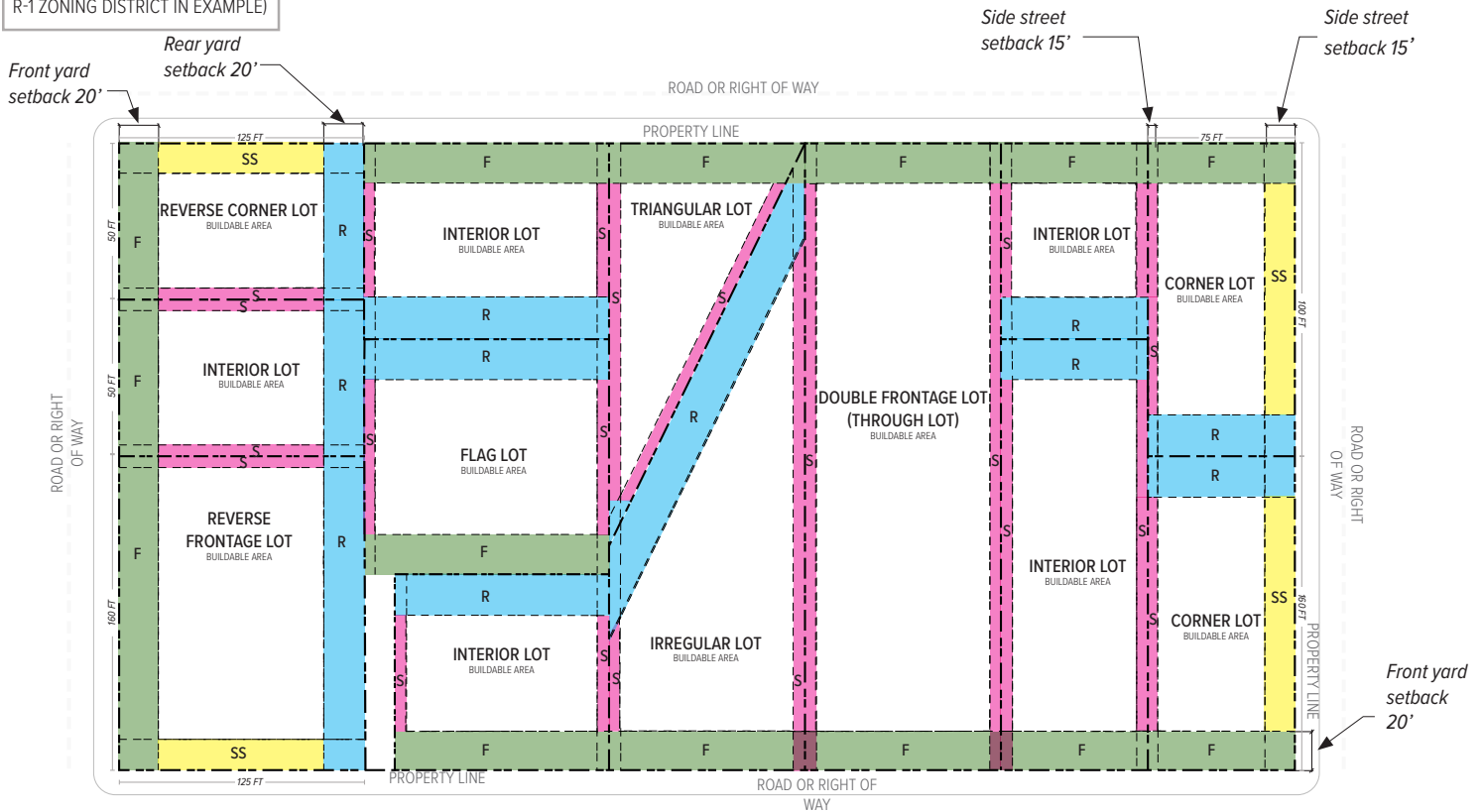
A	Setbacks shall be measured from the normal high water elevation contour on any adjacent natural surface water body and any natural or artificial extension of such water body, for any building or other principal structure. Subject to Chapter 15, Article VII, Lakeshore Protection, and Chapter 15, Article X, Wetland Protection, the minimum setbacks from the normal high water elevation contour on any adjacent natural surface water body, and any natural or artificial extension of such water body, for an accessory building, a swimming pool, swimming pool deck, a wood deck attached to the principal structure or accessory structure, a parking lot, or any other accessory use, shall be the same distance as the setbacks which are used per the respective zoning district requirements as measured from the normal high water elevation contour.  A lot which is part of a subdivision, the plat of which has been lawfully recorded, or a parcel of land, the deed of which was lawfully recorded on or before August 31, 1982, either of which has a depth of less than one hundred fifty (150) feet above the normal high water elevation contour, shall be exempt from the fifty-foot setback requirement set forth in section 38-1501. Instead, the setbacks under the respective zoning district requirements shall apply as measured from the normal high water elevation contour.
B	Side setback is 30 feet where adjacent to single-family district.
C	For lots platted between 4/27/93 and 3/3/97 that are less than 45 feet wide or contain less than 4,500 sq. feet of lot area, or contain less than 1,000 square feet of living area shall be vested pursuant to Article III of this chapter and shall be considered to be conforming lots for width and/or size and/or living area.
D	For attached units (common fire wall and zero separation between units) the minimum duplex lot width is 80 feet, the minimum duplex lot size is 8,000 square feet, and the minimum living area is 500 square feet. For detached units, the minimum duplex lot width is 90 feet, the minimum duplex lot size is 9,000 square feet, and minimum living area is 1,000 square feet, with a minimum separation between units of 10 feet. Fee simple interest in each half of a duplex lot may be sold, devised or transferred independently from the other half. Existing developed duplex lots that are either platted or lots of record existing prior to 3/3/97 and are at least 75 feet in width and have a lot size of 7,500 square feet or greater, shall be deemed to be vested and shall be considered as conforming lots for width and/or size.
E	Multifamily residential buildings in excess of one story in height within 100 feet of the property line of any single-family dwelling district and use (exclusive of 2 story single family and 2 story two-family dwellings), requires a special exception.
F	Reserved.
G	Reserved.
H	For lots platted on or after 3/3/97, or unplatted parcels. For lots platted prior to 3/3/97, the following setbacks shall apply: R-1AA, 30 feet front, 35 feet rear; R-1A, 25 feet front, 30 feet rear; R-1, 25 feet front, 25 feet rear, 6 feet side; R-2, 25 feet front, 25 feet rear, 6 feet side for one (1) and two (2) dwelling units; R-3, 25 feet front, 25 feet rear, 6 feet side for two (2) dwelling units. Setbacks not listed in this footnote shall apply as listed in the main text of this section.
J	Attached units only. If units are detached, each unit shall be placed on the equivalent of a lot 45 feet in width and each unit must contain at least 1,000 square feet of living area. Each detached unit must have a separation from any other unit on site of at least 10 feet.
K	Maximum impervious surface ratio shall be 70%, except for townhouses, nonresidential, and mixed-use development, which shall have a maximum impervious surface ratio of 80%.
L	Subject to the Future Land Use designation.
M	Developable land area.
N	Rear yards and side yards may be reduced to zero (0) when the rear or side property lines about the boundary of a railroad right-of-way, but only in those cases where an adjacent wall or walls of a building or structure are provided with railroad loading and unloading capabilities.
O	One of the side yards may be reduced to zero (0) feet, provided the other side yard on the lot shall be increased to a minimum building setback of fifty (50) feet. This provision cannot be used if the side yard that is reduced is contiguous to a residential district.
P	Rear yards and side yards may be reduced to zero when the rear or side property lines about the boundary of a railroad right-of-way, but only in those cases where an adjacent wall or walls of a building or structure are provided with railroad loading and unloading capabilities; however, no trackage shall be located nearer than three hundred (300) feet from any residential district. The maximum height of any structure shall be two (2) stories or thirty-five (35) feet; provided, that no structure (exclusive of single-family and two-family dwellings) shall exceed one (1) story in height within one hundred (100) feet of the side or rear lot line of any existing single-family residential district.
Q	The maximum height of any structure shall be two stories or thirty-five (35) feet; provided, that no structure (exclusive of single-family and two-family dwellings) shall exceed one story in height within one hundred (100) feet of the side or rear lot line of any existing single-family residential district.
R	A ten-foot front setback may also be permitted for the dwelling unit when a front entry garage is set back at least twenty (20) feet from the front property line.
S	Minimum side building separation is ten (10) feet. The side setback may be any combination to achieve this separation. However, if the side setback is less than five (5) feet, the standards in section 38-605(b) of this district shall apply.

***These requirements are intended for reference only; actual requirements should be verified in the Zoning Division prior to design or construction.***

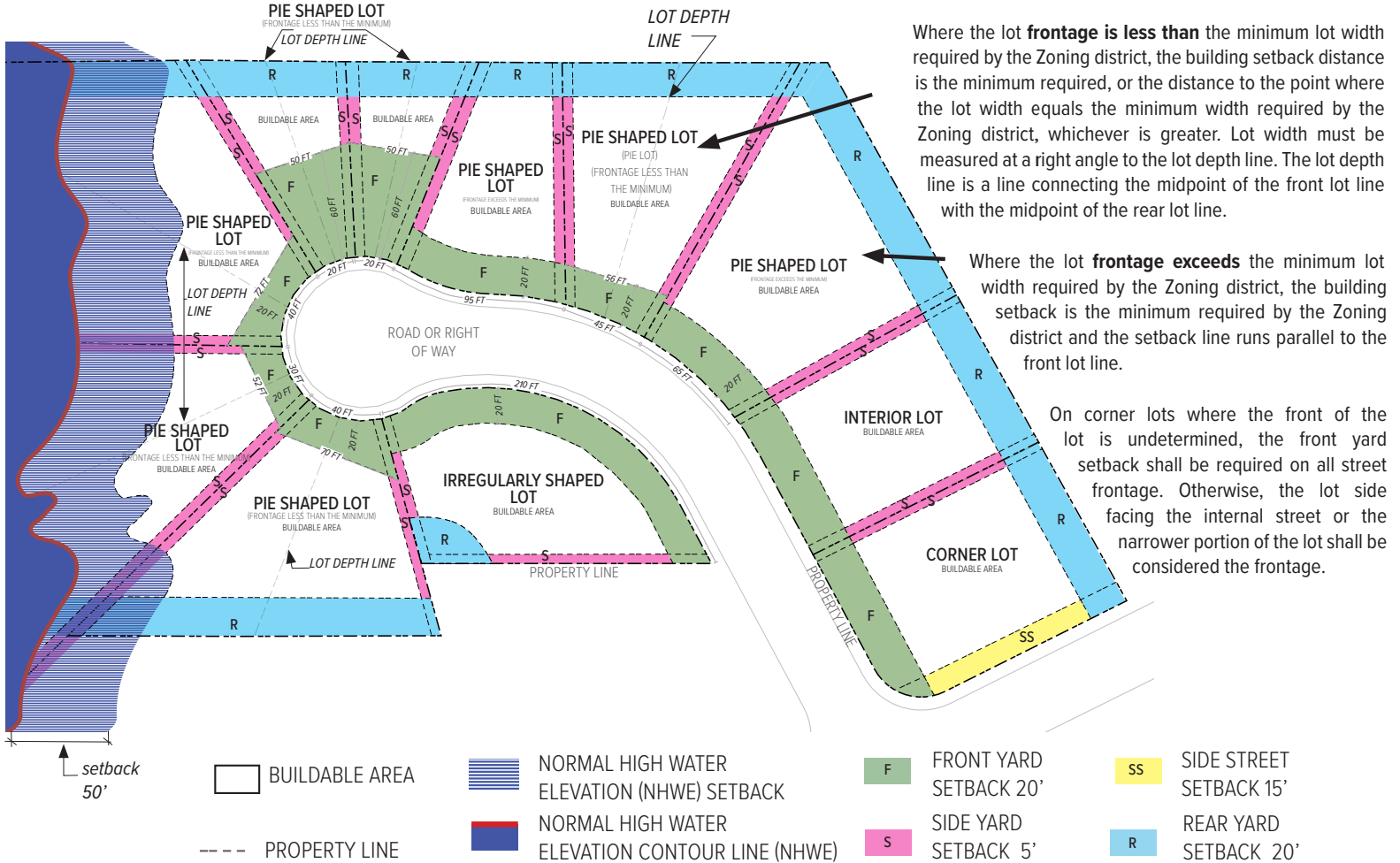


Figure 1. Residential Yard Setback

YARD DETERMINATION (BASED ON R-1 ZONING DISTRICT IN EXAMPLE)



- BUILDABLE AREA
- PROPERTY LINE
- SS SIDE STREET SETBACK 15'
- F FRONT YARD SETBACK 20'
- S SIDE YARD SETBACK 5'
- R REAR YARD SETBACK 20'



Where the lot **frontage is less than** the minimum lot width required by the Zoning district, the building setback distance is the minimum required, or the distance to the point where the lot width equals the minimum width required by the Zoning district, whichever is greater. Lot width must be measured at a right angle to the lot depth line. The lot depth line is a line connecting the midpoint of the front lot line with the midpoint of the rear lot line.

Where the lot **frontage exceeds** the minimum lot width required by the Zoning district, the building setback is the minimum required by the Zoning district and the setback line runs parallel to the front lot line.

On corner lots where the front of the lot is undetermined, the front yard setback shall be required on all street frontage. Otherwise, the lot side facing the internal street or the narrower portion of the lot shall be considered the frontage.

- BUILDABLE AREA
- NORMAL HIGH WATER ELEVATION (NHWE) SETBACK
- F FRONT YARD SETBACK 20'
- SS SIDE STREET SETBACK 15'
- PROPERTY LINE
- NORMAL HIGH WATER ELEVATION CONTOUR LINE (NHWE)
- S SIDE YARD SETBACK 5'
- R REAR YARD SETBACK 20'

## VARIANCE CRITERIA:

Section 30-43 of the Orange County Code Stipulates specific standards for the approval of variances. No application for a zoning variance shall be approved unless the Board of Zoning Adjustment finds that all of the following standards are met:

1. **Special Conditions and Circumstances** – Special conditions and circumstances exist which are peculiar to the land, structure, or building involved and which are not applicable to other lands, structures or buildings in the same zoning district. Zoning violations or nonconformities on neighboring properties shall not constitute grounds for approval of any proposed zoning variance.
2. **Not Self-Created** – The special conditions and circumstances do not result from the actions of the applicant. A self-created hardship shall not justify a zoning variance; i.e., when the applicant himself by his own conduct creates the hardship which he alleges to exist, he is not entitled to relief.
3. **No Special Privilege Conferred** – Approval of the zoning variance requested will not confer on the applicant any special privilege that is denied by the Chapter to other lands, buildings, or structures in the same zoning district.
4. **Deprivation of Rights** – Literal interpretation of the provisions contained in this Chapter would deprive the applicant of rights commonly enjoyed by other properties in the same zoning district under the terms of this Chapter and would work unnecessary and undue hardship on the applicant. Financial loss or business competition or purchase of the property with intent to develop in violation of the restrictions of this Chapter shall not constitute grounds for approval.
5. **Minimum Possible Variance** – The zoning variance approved is the minimum variance that will make possible the reasonable use of the land, building or structure.
6. **Purpose and Intent** – Approval of the zoning variance will be in harmony with the purpose and intent of this Chapter and such zoning variance will not be injurious to the neighborhood or otherwise detrimental to the public welfare.

## SPECIAL EXCEPTION CRITERIA:

Subject to Section 38-78, in reviewing any request for a Special Exception, the following criteria shall be met:

1. The use shall be consistent with the Comprehensive Policy Plan.
2. The use shall be similar and compatible with the surrounding area and shall be consistent with the pattern of surrounding development.
3. The use shall not act as a detrimental intrusion into a surrounding area.
4. The use shall meet the performance standards of the district in which the use is permitted.
5. The use shall be similar in noise, vibration, dust, odor, glare, heat producing and other characteristics that are associated with the majority of uses currently permitted in the zoning district.
6. Landscape buffer yards shall be in accordance with Section 24-5, Orange County Code. Buffer yard types shall track the district in which the use is permitted.

**In addition to demonstrating compliance with the above criteria, any applicable conditions set forth in Section 38-79 shall be met.**

# BZA STAFF REPORT

Planning, Environmental & Development Services/ Zoning Division

Meeting Date: **APR 03, 2025**

Commission District: **#2**

Case #: **SE-25-02-144**

Case Planner: **Laekin O'Hara (407) 836-5943**

**Laekin.O'Hara@ocfl.net**

## GENERAL INFORMATION

**APPLICANT(s):** MARY SOLIK FOR GULFSTREAM TOWERS LLC

**OWNER(s):** DEBORAH GOFF, JAMES GOFF

**REQUEST:** Special Exception and Variance in the A-1 zoning district as follows:

- 1) Special Exception to allow the construction of a 140 ft. high camouflaged monopine communication tower.
- 2) Variance to allow a distance separation of 145 ft. from a single- family residential unit in lieu of 700 ft.

**PROPERTY LOCATION:** 3820 Yothers Rd., Apopka, Florida 32712, south side of Yothers Rd., west of S.R. 429, east of W. Orange Blossom Trl., north of Windward Hills Blvd.

**PARCEL ID:** 36-20-27-0000-00-065

**LOT SIZE:** +/- 1.93 acres

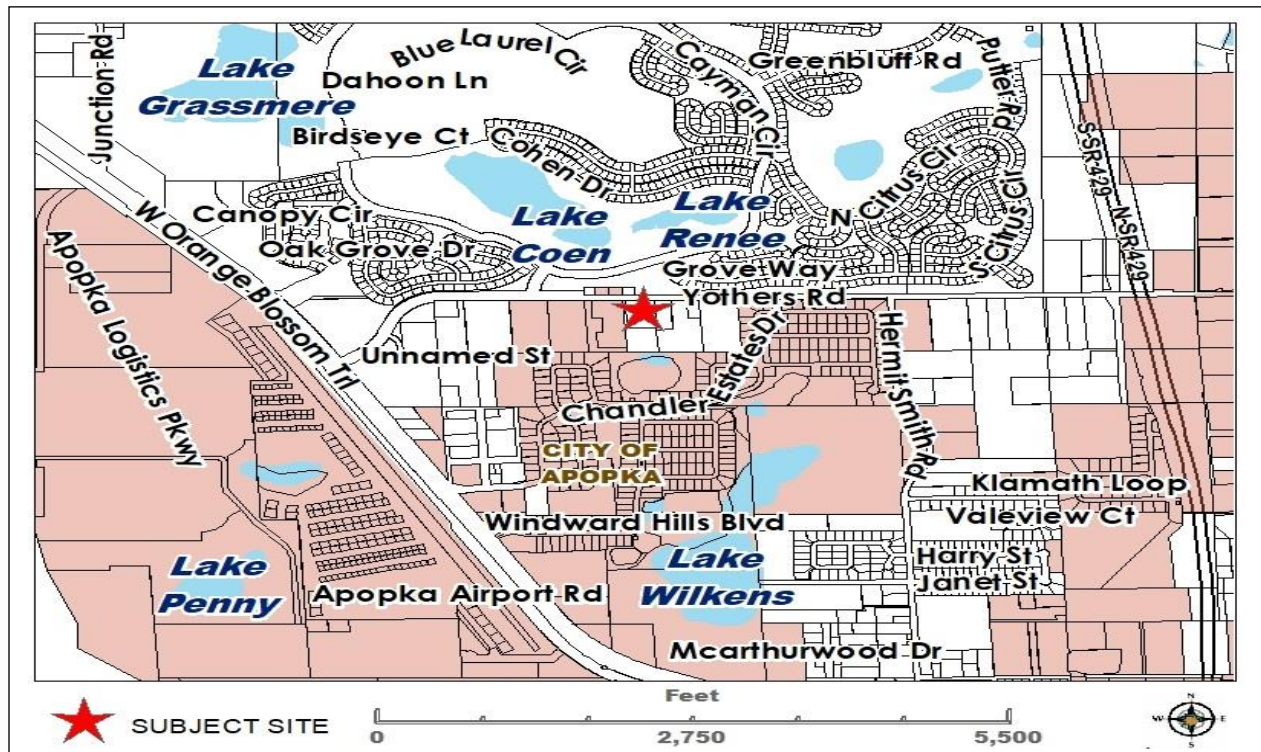
**NOTICE AREA:** 800 ft.

**NUMBER OF NOTICES:** 109

## STAFF RECOMMENDATIONS

Approval, subject to the conditions in this report.

## LOCATION MAP



---

**SITE & SURROUNDING DATA**

---

	Property	North	South	East	West
Current Zoning	A-1	Zellwood Station PD	A-1	A-1	City of Apopka
Future Land Use	Rural	Low Density Residential	Rural	Rural	City of Apopka
Current Use	Agricultural Grazing Pasture	Vacant	Single-Family Residential	Single-Family Residential	Agricultural Nursery

---

**BACKGROUND AND ANALYSIS**

---

**DESCRIPTION AND CONTEXT**

The subject property is located in the A-1, Citrus Rural district, which primarily allows agricultural uses, nurseries and greenhouses, as well as mobile homes and single-family homes on larger lots. A monopole communications tower is permitted by right or by Special Exception in the A-1 zoning district, depending on whether or not it meets a variety of requirements. The future land use is Rural (R), which is consistent with the A-1 zoning district.

The subject property is 1.93 acres in size, is a conforming lot, and is currently utilized as a grazing pasture. Florida Statute 604.50 states lands used for bona fide agricultural purposes are exempt from the Florida Building Code and any county or municipal code. The property has an active agricultural classification for the grazing pasture use, therefore, the grazing pasture use and any associated structures are subject to this statute.

The subject request is to erect a 140 ft. high camouflaged monopine communication tower, designed for multiple carriers and colocation opportunities, within a 90 ft. by 40 ft. leased compound facility at the south end of the property. No buildings, specimen trees, or heritage trees will be removed for installation.

Orange County Code Section 38-1427 provides performances standards for communication towers, including but not limited to, separation from off-site uses and distance separation between communication towers. Additional conditions related to permitted towers and those requiring a Special Exception are found in Section 38-79, conditions 32 and 143. Condition 32 allows a communication tower by-right in agriculturally and residentially zoned lands not located within a Rural Settlement. Condition 143 allows a monopole up to 170 ft. in height by right if there is co-location and distance separations are met, otherwise a Special Exception is required. Although it is being designed for colocation opportunities, the proposed tower will have no colocation at the time of installation, and therefore the applicant is requesting a Special Exception. In addition to this, the off-site distance separation requirements are not met, which would also require a Special Exception.

The proposed monopole tower complies with the required performance standards pertaining to setbacks, landscaping for the tower and the distance separation from the nearest tower. It is 1.49 miles (7,867 ft.) from the nearest existing monopole communication tower where a minimum of 2,500 ft. is required. However, the tower is proposed to be located 145 ft. from the nearest off-property residential use or district, located at 3792 Yothers

Rd., where a minimum of 700 ft. is required, prompting the need for the Variance request. In addition to this residence, which is owned by the same owners of the subject site, there are three (3) other residences located along Yothers Rd. that the proposed tower would not meet the distance separation from.

**Proposed off-site Distance Separation**

Address	Use	Proposed Distance
3800 Yothers Rd.	Single-family residential	284 ft.
3835 Yothers Rd.	Single-family residential	359 ft.
3996 Yothers Rd.	Single-family residential	422 ft.

Section 38-1427(d)(2)(c) allows the Zoning Manager to reduce the distance separations when notarized written consent is obtained from those affected property owners within the applicable separation distance. The owners of the single-family residence located at 3792 Yothers Rd. provided a letter of consent for the proposed communication tower to be located within 149 ft. of their residence. This distance of 149 ft. is also noted in the applicant’s cover letter; however, the plans identify a closer distance of 145 ft. which is what was advertised. Letters of consent from the owners of the other three (3) properties have not been received, therefore, the Variance request is required for the distance separation.

Section 38-1427(n)(6) allows for the distance separation to be reduced by half by the BZA when it is determined that the camouflaging agent is compatible with the surrounding area. The BZA’s support of the proposed camouflaging agent would reduce the required residential distance separation from 700 ft. to 350 ft., thereby eliminating the need for the request for all but two residences.

On Thursday, February 20, 2025, a Community Meeting was held at Wolf Lake Middle School. The meeting was attended by the applicant and County staff. There was no public attendance for the Community Meeting.

A second Community Meeting will be held on Wednesday, March 26, 2025, at Wolf Lake Middle School. Information regarding this meeting will be provided at the BZA public hearing.

The request was routed to all reviewing divisions and no objections were provided. As of the date of this report, no comments have been received in favor or in opposition to this request.

**Communication Tower Development Standards**

	Code Requirement	Proposed
Max Height:	170 ft. by right, greater via Special Exception	140 ft.
Front (Yothers Rd.):	35 ft.	262.5 ft. (North)
Rear:	50 ft.	70 ft. (South)
Side:	10 ft.	126 ft. (West) 126 ft. (East)

**Communication Tower Distance Separation Standards**

	Code Requirement	Proposed
Tower Separation:	2,500 ft.	1.49 miles (7,867 ft.)
Residential Use Separation:	700 ft. 350 ft. (if camouflaging is approved by BZA)	145 ft. (Variance)

Section 30-43 (2) of the Orange County Code stipulates a recommendation of approval can only be made if all six (6) Special Exception criteria are met. The request meets all the criteria. Therefore, staff is recommending approval of the Special Exception request.

Section 30-43 (3) of the Orange County Code stipulates a recommendation of approval can only be made if all six (6) Variance criteria are met. The request meets all the criteria. Therefore, staff is recommending approval of the Variance request.

---

**STAFF FINDINGS**

---

**SPECIAL EXCEPTION CRITERIA FOR COMMUNICATION TOWERS**

This request has been assessed based upon the six Special Exception criteria as set forth in Section 30-43(2) as well as the two additional criteria as set forth in Section 1427(n)(7) and as such staff recommends approval of the request.

**Consistent with the Comprehensive Plan**

MET – The provision of telecommunication towers as conditioned through the Special Exception process is consistent with the Comprehensive Plan.

**Similar and compatible with the surrounding area**

MET – The new communication tower will be located at the rear portion of the property and is camouflaged to blend in with the surrounding trees. It will be similar and compatible with the surrounding uses in the area since the proposed tower location is on a portion of the site that will minimize adjacent visual impacts.

**Shall not act as a detrimental intrusion into a surrounding area**

MET – The proposed communication tower will be surrounded by the existing agricultural uses and single-family residences and will not negatively impact the surrounding area since the tower is camouflaged to blend in with the surrounding trees. The closest residence is the home of the subject site’s owners and therefore should be located at an adequate distance to minimize visual impacts and as such will not be a detrimental intrusion to the surrounding area.

**Meet the performance standards of the district**

MET (with Variance approval) – As proposed the tower will not comply with the minimum distance separation from a single- family residential unit. However, with the approval of the requested Variance, as recommended by staff, the proposed communication tower will meet the performance standards of the district.

**Similar in noise, vibration, dust, odor, glare, heat production**

MET – The proposed monopole tower will not generate noise, vibration, dust, odor, glare, or heat that is not similar to the existing nurseries in the surrounding area.

**Landscape buffer yards shall be in accordance with Section 24-5 of the Orange County Code**

MET – The applicant has provided a landscape plan which addresses perimeter landscaping in compliance with Section 24-5 of Orange County Code.

**Aesthetic Impact. View of a tower that is not camouflaged. Aesthetic impact shall take into consideration, but not be limited to, the amount of the tower that can be viewed from surrounding residential zones in conjunction with its proximity (distance) to the residential zone, mitigation landscaping, existing character of surrounding area, or other visual options proposed.**

MET – The tower is proposed to be camouflaged as a pine tree and located 145 feet from the nearest residential use or district and over 1.49 miles from the nearest communication tower. Furthermore, as affirmed by the visuals provided by the photo simulation, the tower location relative to the proximity of the closest residences, will have a limited aesthetic impact.

**Compatibility. The degree to which the proposed tower is designed and located is compatible with the nature and character of other land uses and/or with the environment within which the tower proposes to locate.**

MET – The proposed tower will be placed and designed to mitigate the overall aesthetic impact of a tower as the tower will be camouflaged to provide compatibility with the surrounding vegetation.

**VARIANCE CRITERIA**

**Special Conditions and Circumstances**

MET – The special condition and circumstances specific to the subject site is the lack of other opportunities to locate a tower on the proposed property without the need for a Variance.

**Not Self-Created**

MET – The request is not self-created since the applicant is not responsible for the location, size and configuration of property adjacent to residences.

**No Special Privilege Conferred**

MET – Granting the Variance as requested will not confer special privilege since the use is permitted by right within the A-1 zoning district.

**Deprivation of Rights**

MET – Without the requested Variance, the owner would be deprived of the ability to erect a communication tower on the site in an appropriate location to minimize adjacent visual impacts.

**Minimum Possible Variance**

MET – The requested Variance is the minimum possible to allow the installation of a maximum 140 ft. high tower while meeting all other performance standards for the district.

## Purpose and Intent

MET – Approval of the requested Variances will be in harmony with the purpose and intent of the Zoning Regulations as the code is primarily focused on minimizing the impact that structures have on surrounding properties. The proposed will not be detrimental to the area, as affirmed by the visuals provided by the photo simulation.

---

## CONDITIONS OF APPROVAL

---

1. Development shall be in accordance with the site plan and tower specifications dated February 5, 2025, subject to the conditions of approval, and all applicable laws, ordinances, and regulations. Any proposed non-substantial deviations, changes, or modifications will be subject to the Zoning Manager's review and approval. Any proposed substantial deviations, changes, or modifications will be subject to a public hearing before the Board of Zoning Adjustment (BZA) where the BZA makes a recommendation to the Board of County Commissioners (BCC).
  2. Pursuant to Section 125.022, Florida Statutes, issuance of this development permit by the County does not in any way create any rights on the part of the applicant to obtain a permit from a state or federal agency and does not create any liability on the part of the County for issuance of the permit if the applicant fails to obtain requisite approvals or fulfill the obligations imposed by a state or federal agency or undertakes actions that result in a violation of state or federal law. Pursuant to Section 125.022, the applicant shall obtain all other applicable state or federal permits before commencement of development.
  3. Any deviation from a Code standard not specifically identified and reviewed/addressed by the Board of County Commissioners shall be resubmitted for the Board's review or the plans revised to comply with the standard.
  4. A permit for the communication tower shall be obtained within 3 years of final action on this application by Orange County or this approval is null and void. The zoning manager may extend the time limit if proper justification is provided for such an extension.
  5. The communication tower shall be designed and constructed to accommodate at least one (1) other service provider.
  6. A notarized letter acknowledging that the communication tower is designed and will be constructed to accommodate at least one (1) other service provider shall be provided at the time of permitting.
  7. All service providers shall cooperate in good faith with other service providers to accomplish co-location of additional antennas on communication towers which are existing, permitted, or otherwise authorized by Orange County, where feasible.
- C: Mary D. Solik, Esq.  
121 S. Orange Ave., Suite 1500  
Orlando, FL 32801





December 11, 2024

VIA email: BZA@ocfl.net

Orange County Zoning Division  
201 South Rosalind Ave., 1<sup>st</sup> Floor  
Orlando, FL 32801

RE: Gulfstream Towers Special Exception Application  
FL252 Zellwood SE

To Whom it May Concern:

This firm represents Gulfstream Towers, LLC, the applicant for the referenced Special Exception application. Submitted in support of the application are the following materials:

- Completed Application Form
- Agent Authorization Form
- Project Expenditure Report
- Relationship Disclosure Form
- Special Exception Criteria Analysis
- Property Survey
- Site Plan
- Project Narrative
- Consents to Reduced Setback
- Photo Simulation
- Camouflaged Facilities Analysis
- Determination of Feasibility
- Search Ring Package
- Affidavit of Mike Burkhead RE: Construction, Collocation, and Existing Facilities

Please advise if any additional information is required.

Very truly yours,

Mary D. Solik, Esq.

CC: Michael Burkhead

## **GULFSTREAM TOWERS, LLC: FL252 ZELLWOOD SE**

### **Project Narrative**

Gulfstream Towers, LLC proposes the construction of a 140' Telecommunications Facility (135' Monopine Tower with a 5' Lightning Rod) on property located at 3820 Yothers Road, Apopka, FL 32832. The 1.93 acre parent parcel is owned by James C. And Deborah A. Goff. The parent tract is currently pasture with a small barn. Mr. & Mrs. Goff also own the 5.16 acres of land to the east of the subject property which includes their homestead. The property has a FLU designation of Rural and is zoned A-1. Telecommunications Towers are permitted as a Special Exception use in A-1 zoning.

The Site plan submitted with the applications demonstrates that the Proposed Telecommunications Tower meets all performance criteria for telecommunications towers set forth in Section 38-1427, Orange County LDC. More specifically the following criteria are met:

- The Proposed Tower meets the Zoning District setbacks.
- The Proposed Tower meets the tower to tower separation requirements. The closest offsite tower is a 190' Monopole Tower requiring a 2,500 foot separation. The tower is located \_1.49 miles from the Proposed Tower, far exceeding the separation requirement.
- The standard setback from residential structures for a 140' tower is 700'. The Proposed Tower has been designed as camouflage structure, a Monopine, which qualifies it for a 50% setback reduction from any offsite residential structure. The Proposed Tower is 149' from the closest residential structure which is the Goff homestead to the east. The Goffs have signed a Notarized Consent to the Reduced Separation requirement.
- No tower lighting is proposed.
- Code compliant landscaping is proposed for the base of the Proposed Tower.
- The Proposed Tower will be designed to accommodate 4 users.
- The Proposed Tower has been located so as to eliminate any specimen or heritage tree removal.

**SPECIAL EXCEPTION CRITERIA**

1. The use shall be consistent with the Comprehensive Policy Plan.

The Proposed Telecommunications Tower as an approved Special Exception use is consistent with the Comprehensive Policy Plan.

---

---

---

2. The use shall be similar and compatible with the surrounding area and shall be consistent with the pattern of surrounding development.

The immediately surrounding development is sparsely developed and primarily rural.

---

---

---

3. The use shall not act as a detrimental intrusion into a surrounding area.

The Proposed Tower will not be a detrimental intrusion into the surrounding. It will provide expanded wireless service and will enhance public safety with expanded E911 service.

---

---

---

4. The use shall meet the performance standards of the district in which the use is permitted.

All performance criteria set forth in Section 38-1427 Communication towers have been met.

---

---

---

5. The use shall be similar in noise, vibration, dust, odor, glare, heat producing and other characteristics that are associated with the majority of uses currently permitted in the zoning district.

The Proposed Telecommunications Tower does not create any noise, vibration, dust, odor, glare or heat.

---

---

---

6. Landscape buffer yards shall be in accordance with section 24-5 of the Orange County Code. Buffer yard types shall track the district in which the use is permitted.

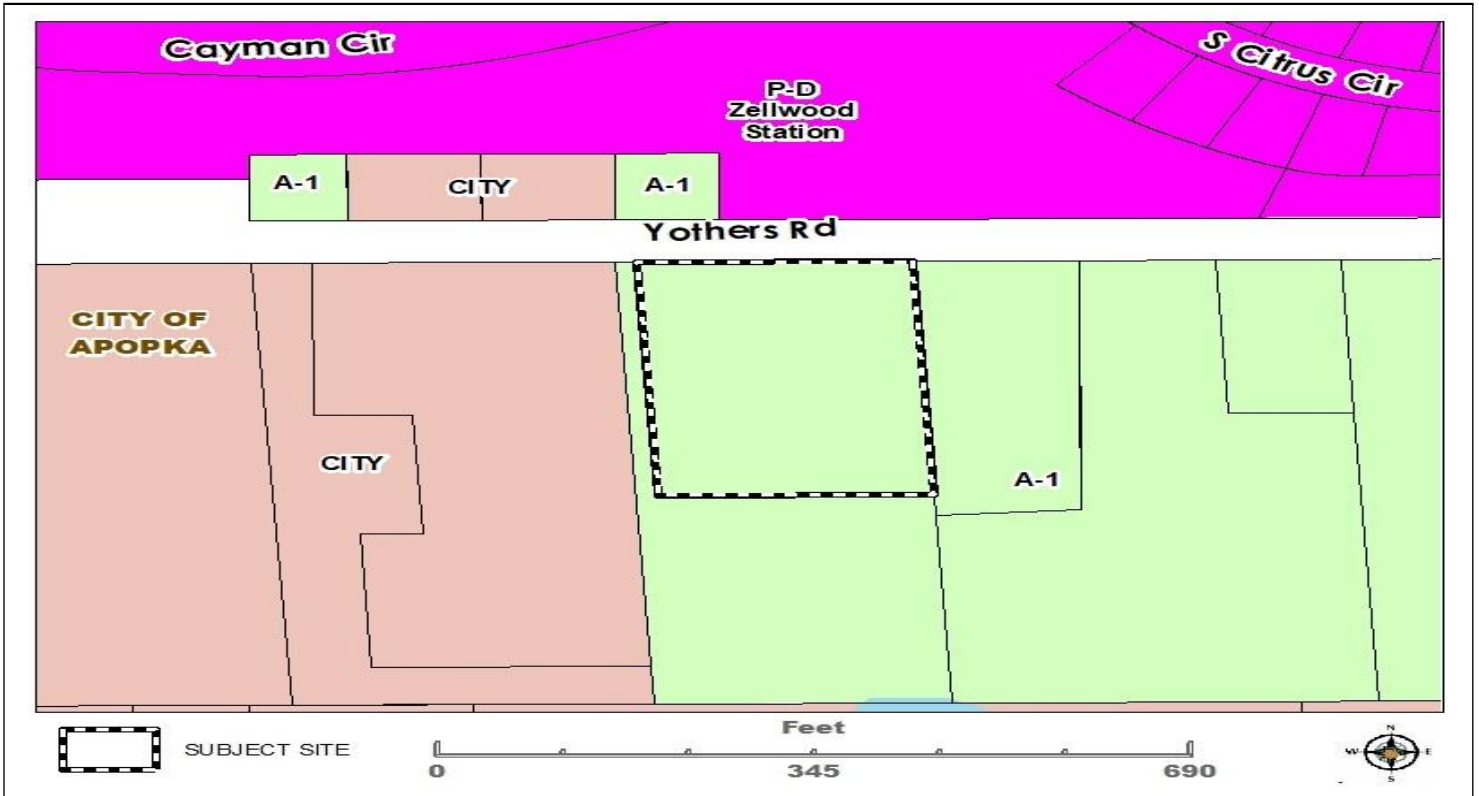
Landscaping consistent with Section 38-1427(d)(11) is provided on Site Plan.

---

---

---

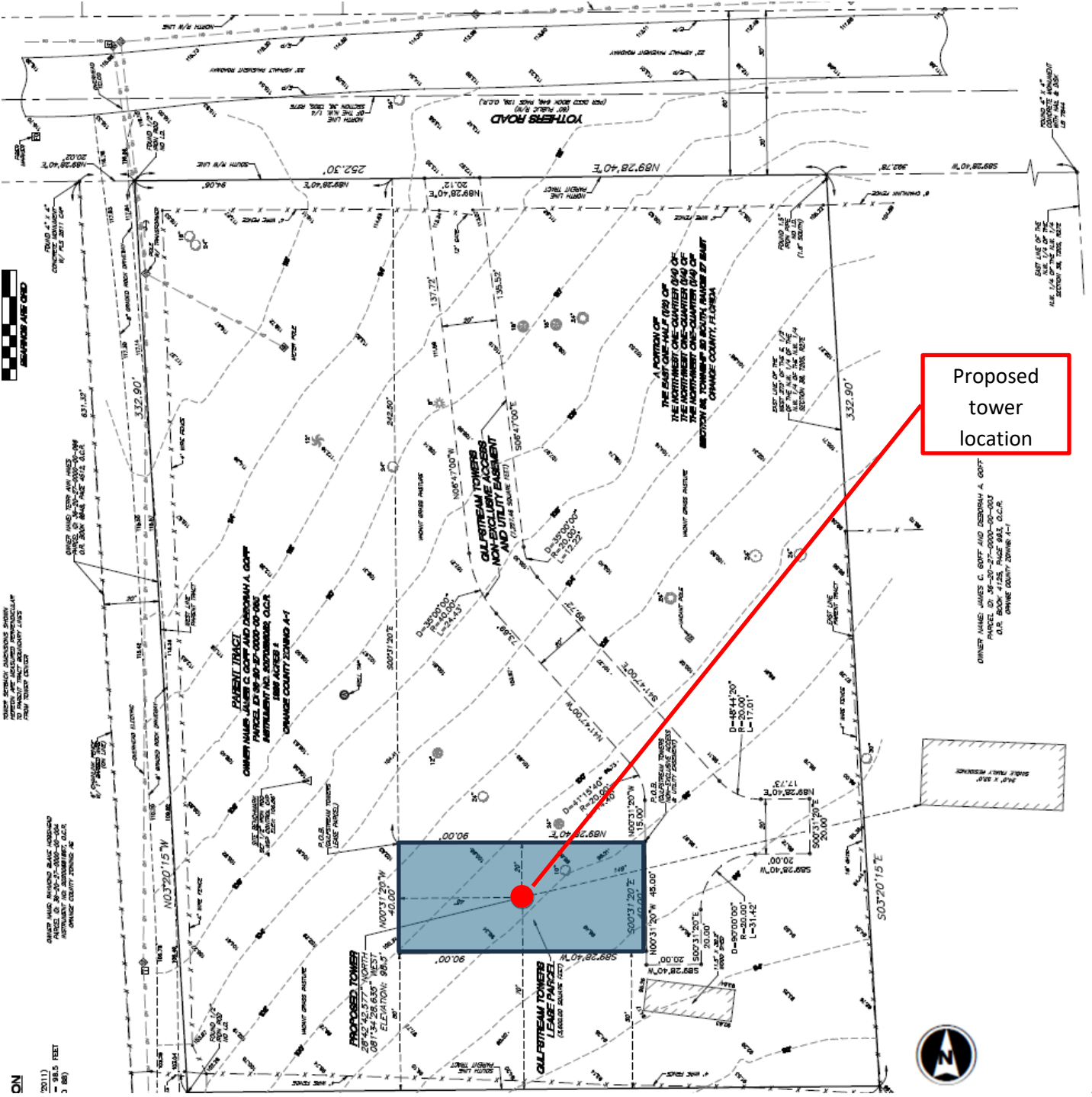
ZONING MAP



AERIAL MAP



PARENT TRACT



2011  
 98.5 FEET  
 3 88'

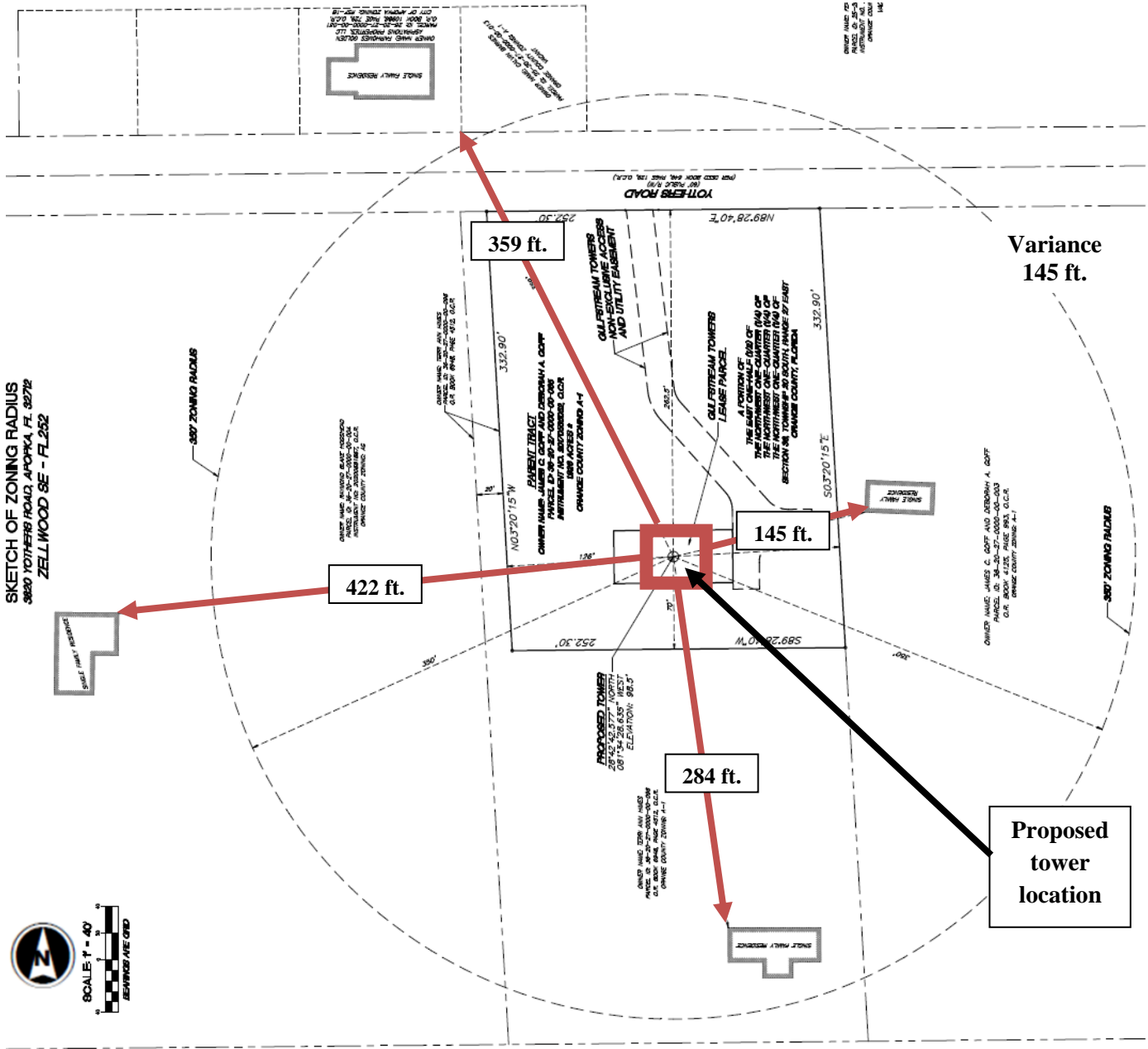


Proposed tower location

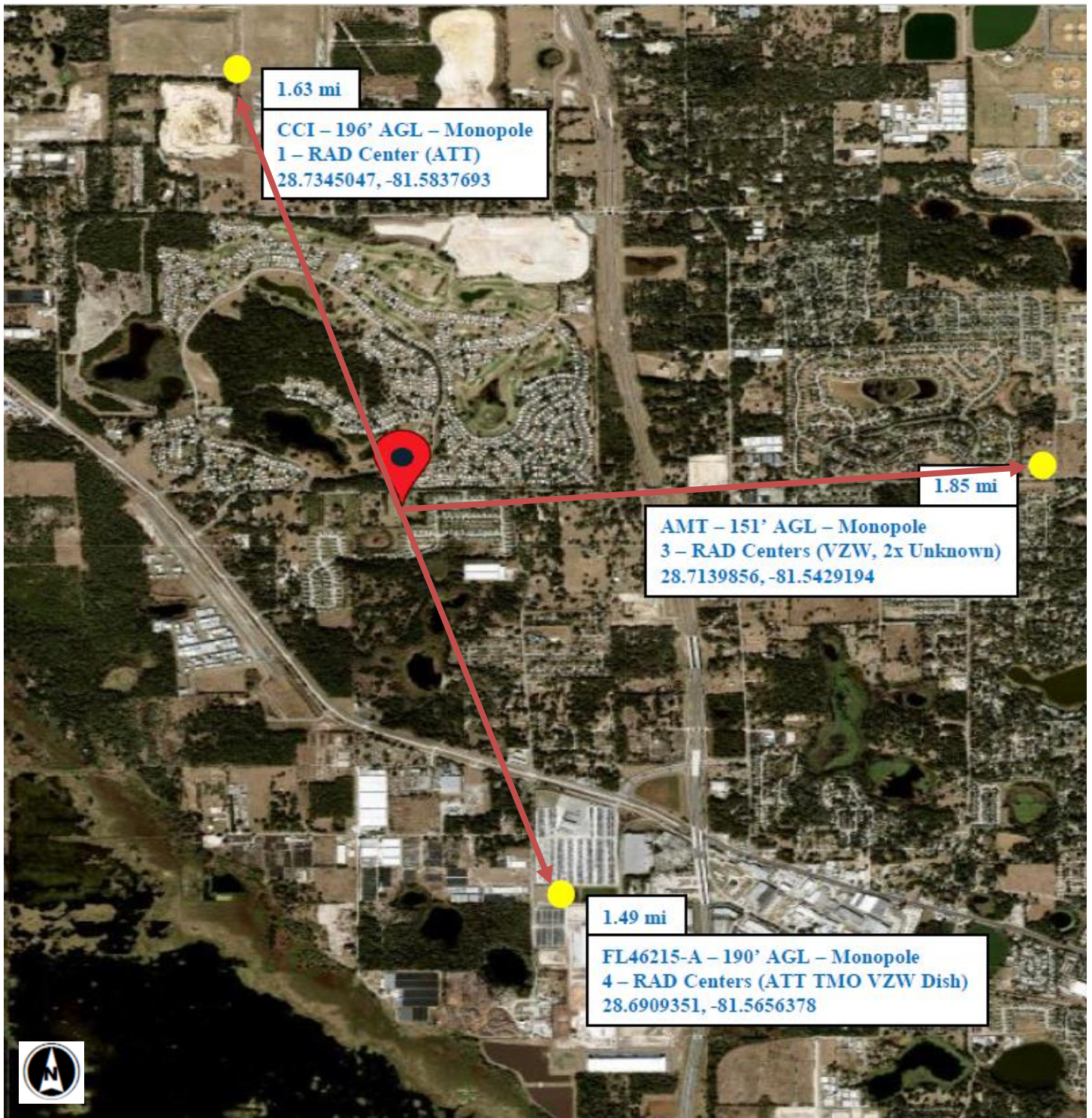
OWNER NAME: JAMES C. GOFF AND DEBORAH A. GOFF  
 PARCEL ID: 30-20-27-0000-00-003  
 O.P.E. SURVEY: 1987, 1988, 1989, 1990, 1991, 1992, 1993, 1994, 1995, 1996, 1997, 1998, 1999, 2000, 2001, 2002, 2003, 2004, 2005, 2006, 2007, 2008, 2009, 2010, 2011  
 ORANGE COUNTY ZONING: P-1

40' x 30'

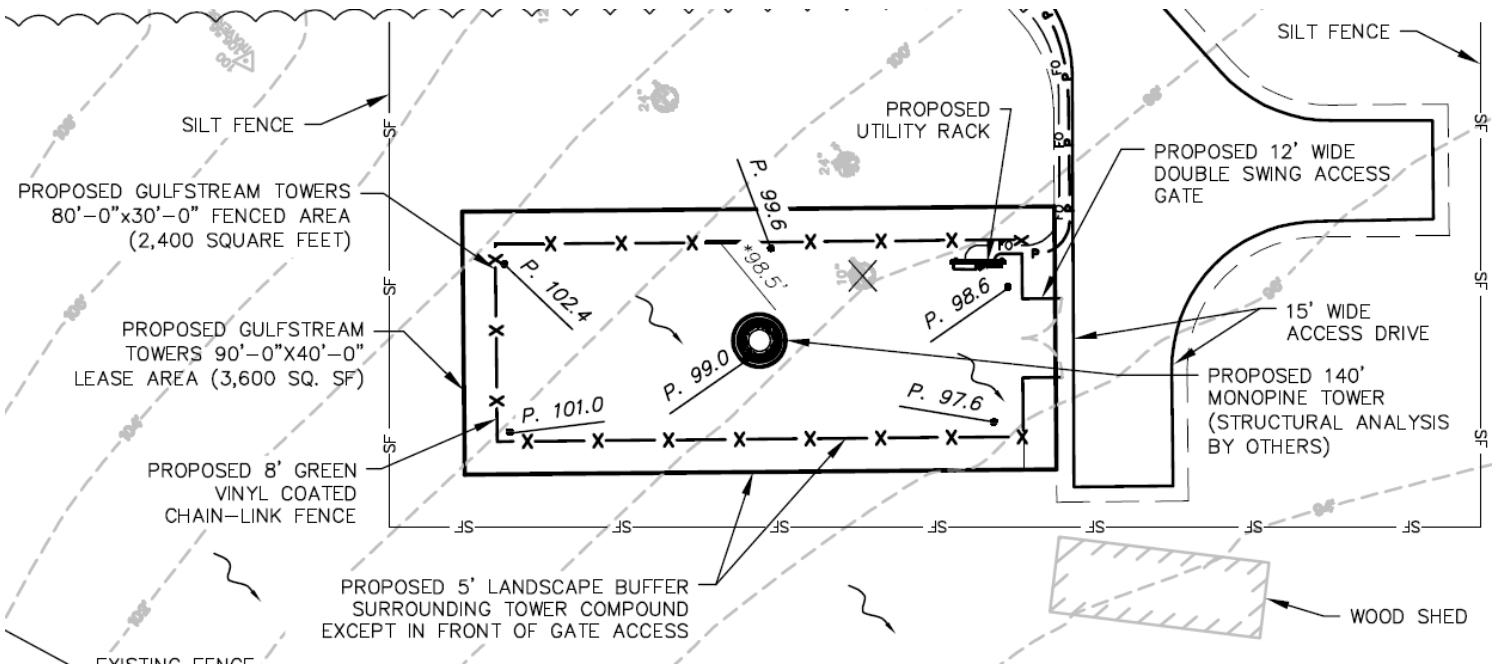
# OVERALL RESIDENTIAL DISTANCE SEPARATION



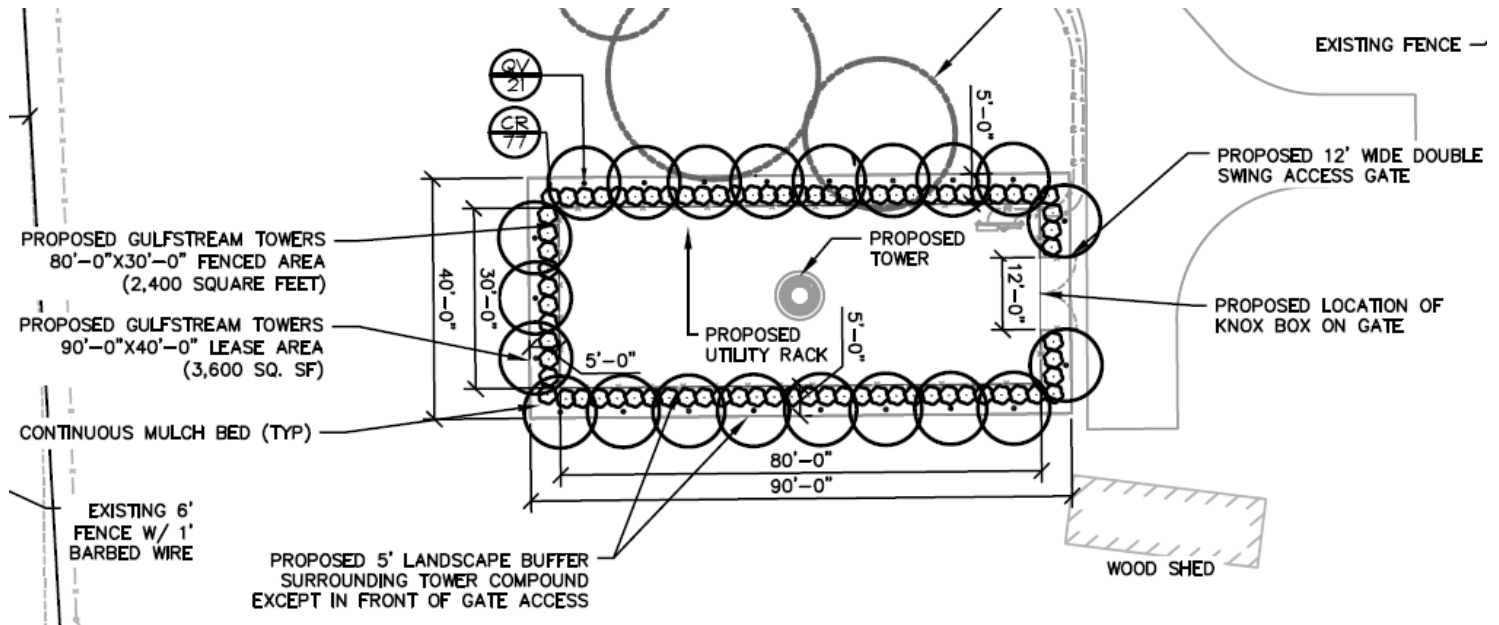
DISTANCE SEPARATION TO NEAREST TOWER



## TOWER LOCATION LAYOUT

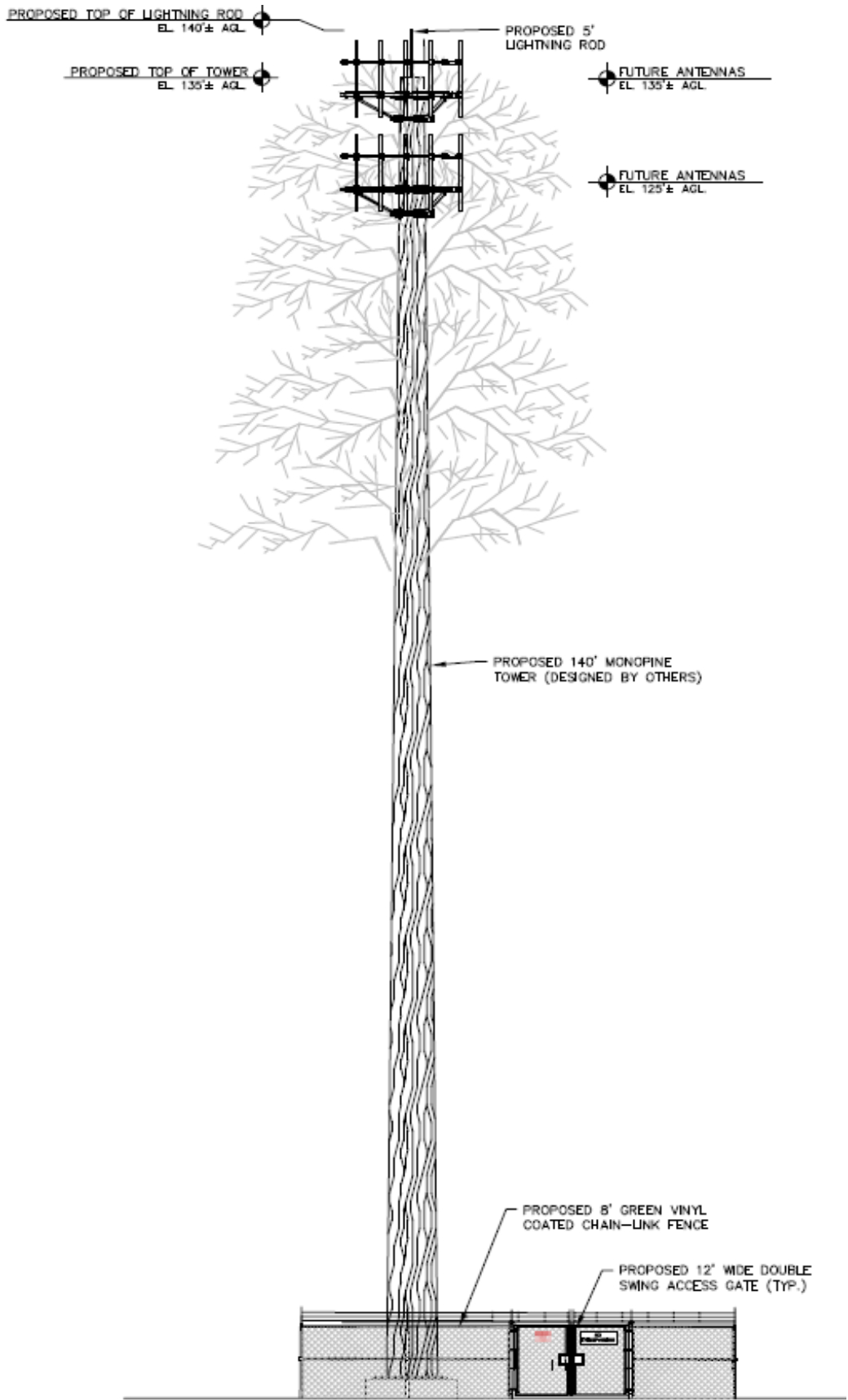


## TOWER LEASE AREA LANDSCAPE PLAN





# TOWER ELEVATION



KEY PROVIDED BY  
EYORS & MAPPERS.

**TOWER ELEVATION**  
N.T.S.

PHOTO SIMULATIONS FROM APPLICANT

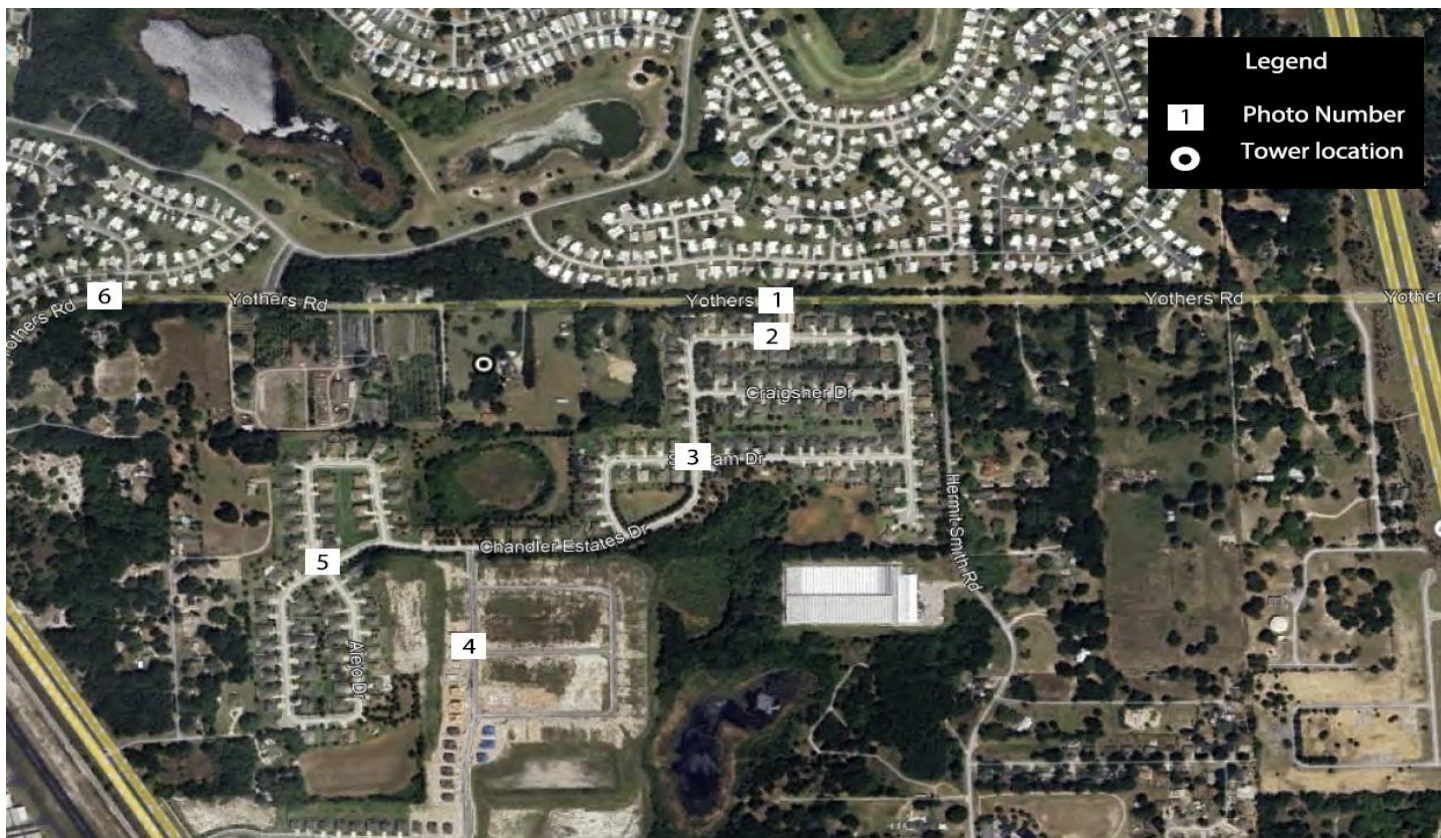


Photo simulation legend



View 1 facing west from the intersection of Yothers Rd. and Jeffmar Blvd.

**PHOTO SIMULATIONS FROM APPLICANT**



**View 2 facing southwest from the intersection of Chandler Estates Dr. and Jeffmar Blvd.**



**View 3 facing northwest from the intersection of Chandler Estates Dr. and Statham Dr.**

PHOTO SIMULATIONS FROM APPLICANT



View 4 facing north from Windward Hills Blvd.



View 5 facing northeast from Chandler Estates Dr.

**PHOTO SIMULATIONS FROM APPLICANT**



**View 6 facing east from Yothers Rd. No view of the proposed tower**

**SITE PHOTOS**



**Front of property facing south from Yothers Rd. towards proposed tower location**

---

**SITE PHOTOS**

---



**Facing north at rear property line towards proposed tower location, Yothers Rd. in background**



**Facing south towards neighboring residence 284 ft. from the proposed tower location**

---

**SITE PHOTOS**

---



**Facing northwest towards neighboring residence 359 ft. from the proposed tower location**



**Facing west towards neighboring residence 422 ft. from the proposed tower location**

# BZA STAFF REPORT

Planning, Environmental & Development Services/ Zoning Division

Meeting Date: **APR 03, 2025**

Commission District: **#3**

Case #: **VA-25-02-124**

Case Planner: **Catherine Glase (407) 836-9615**

**Catherine.Glase@ocfl.net**

## GENERAL INFORMATION

**APPLICANT(s):** CHRIS REED

**OWNER(s):** GEORGE SHEPHERD

**REQUEST:** Variances in the R-1A zoning district as follows:

- 1) To allow a residence with less than the minimum living area of 1,200 sq. ft.
- 2) To allow a residence with a 2.39 ft. west rear setback in lieu of 30 ft.
- 3) To allow a residence with a 3.22 ft. north side setback in lieu of 7.5 ft.
- 4) To allow a residence with a 10.47 ft. east front setback in lieu of 25 ft.

**PROPERTY LOCATION:** 1412 Winn Avenue, Orlando, Florida 32806, west side of Winn Ave., north of Curry Ford Rd., east of S. Bumby Ave., south of S.R. 408, west of S. Crystal Lake Dr.

**PARCEL ID:** 31-22-30-3324-04-013

**LOT SIZE:** +/- 3,546 sq. ft.

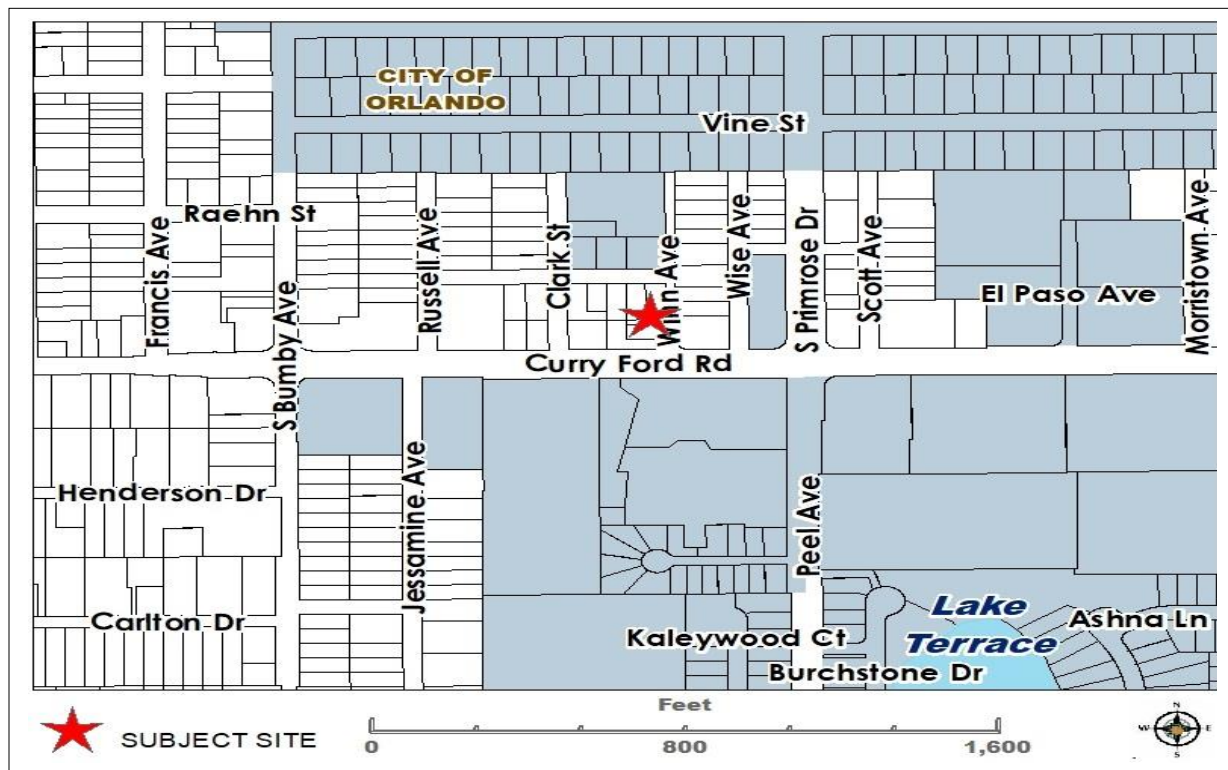
**NOTICE AREA:** 500 ft.

**NUMBER OF NOTICES:** 198

## STAFF RECOMMENDATIONS

**CONTINUED TO MAY 1, 2025, BZA MEETING**

## LOCATION MAP





# BZA STAFF REPORT

Planning, Environmental & Development Services/ Zoning Division

Meeting Date: **APR 03, 2025**

Commission District: **#3**

Case #: **VA-25-03-003**

Case Planner: **Catherine Glase (407) 836-9615**

**Catherine.Glase@ocfl.net**

## GENERAL INFORMATION

**APPLICANT(s):** RYAN ERICKSON

**OWNER(s):** VICKY SUE PELL SIMMONS

**REQUEST:** Variance in the R-1A zoning district to allow a minimum lot width of 60 ft. in lieu of 75 ft.

**PROPERTY LOCATION:** 1600 Jessamine Ave., Orlando, Florida 32806, west side of Jessamine Ave., north of E. Kaley Ave., east of S. Bumby Ave., south of Curry Ford Rd., west of S. Crystal Lake Dr.

**PARCEL ID:** 06-23-30-3328-02-250

**LOT SIZE:** +/- 8,101 sq. ft.

**NOTICE AREA:** 500 ft.

**NUMBER OF NOTICES:** 82

## STAFF RECOMMENDATIONS

Approval, subject to the conditions in this report.

## LOCATION MAP



**SITE & SURROUNDING DATA**

	Property	North	South	East	West
Current Zoning	R-1A	R-1A	R-2	Restricted R-2	R-2
Future Land Use	LMDR	LMDR	LMDR	LMDR	LMDR
Current Use	Vacant	Single-family residential	Single-family residential	Single-family residential	Single-family residential

**BACKGROUND AND ANALYSIS**

**DESCRIPTION AND CONTEXT**

The subject property is located in the R-1A, Single-Family Dwelling district, which allows single-family homes and associated accessory structures. The future land use is Low Medium Density Residential (LMDR), which is consistent with the R-1A zoning district.

The area around the subject site consists of single-family homes and some commercial to the north. The subject property is 8,101 sq. ft. in size, was platted in 1925 as lot 25 and a portion of lot 26 in Block B of the Handsonhurst Park Plat and is considered to be a substandard lot due to the width of the lot. Per Orange County Code Sec. 38-1401, if two or more adjoining lots were under single ownership on or after October 7, 1957, and one of the lots has a frontage or lot area less than what is required by the zoning district, such substandard lot or lots shall be aggregated to create one conforming lot. The subject lot was in contiguous ownership with lot 26 to the north between 1945 and 1973. In 1973 the subject lot was sold in its current configuration with a portion of lot 26. As such, the subject lot is not considered a substandard lot of record. There was a single-family home on the lot which was demolished in 2024. The current owner purchased the lot in 1994, and the applicant is currently working to purchase the property pending the outcome of the Variance request.

The applicant is proposing to construct a two-story, 4,245 gross sq. ft. residence with 2,222 sq. ft. of living area. The residence includes a 2-car attached garage with a 785 sq. ft. attached accessory dwelling unit over the garage. The R-1A zoning district requires a minimum lot width of 75 ft., the existing lot width is 60 ft., requiring the Variance request. The proposed residence and attached accessory dwelling unit comply with all other zoning development standards.

The request was routed to all reviewing divisions and no objections were provided. As of the date of this report, no comments have been received in favor or in opposition to this request.

Section 30-43 (3) of the Orange County Code stipulates a recommendation of approval can only be made if all six (6) Variance criteria are met. Staff has determined that the Variance request meets all the criteria. Therefore, staff is recommending approval of the Variance request.

**District Development Standards**

	Code Requirement	Proposed
Max Height:	35 ft.	25.25 ft.
Min. Lot Width:	75 ft.	60 ft. (Variance request)
Min. Lot Size:	7,500 sq. ft.	+/- 8,101 sq. ft.

**Building Setbacks**

	Code Requirement	Proposed
Front:	25 ft.	25 ft. (East)
Rear:	30 ft.	36.67 ft. (West)
Side:	7.5 ft.	8.75 ft. (North) 7.5 ft. (South)

---

**STAFF FINDINGS**


---

**VARIANCE CRITERIA****Special Conditions and Circumstances**

MET – The special conditions and circumstance particular to the subject property are that the lot will be undevelopable without the requested Variance for lot width.

**Not Self-Created**

MET – The substandard aspects of the parcel are not self-created, as the lot was in this configuration when the current owner purchased the property.

**No Special Privilege Conferred**

MET – Granting the Variance would not confer special privilege as the surrounding developed properties in the area contain homes on similar sized lots.

**Deprivation of Rights**

MET – Without approval of the requested Variance, the owner will be deprived of the ability to construct a residence on the parcel.

**Minimum Possible Variance**

MET – The requested Variance is the minimum necessary to construct a home on the property.

**Purpose and Intent**

MET – Approval of the request will be in harmony with the purpose and intent of the Code, which is to allow infill development of lawfully constructed residences. The lot width will not be detrimental to the neighborhood as the proposed width will be consistent with the majority of the lots in the area. Additionally, the proposed residence complies with all other zoning development standards, including lot size and setbacks.

---

## CONDITIONS OF APPROVAL

---

1. Development shall be in accordance with the lot width dimension shown on the site plan date stamped January 22, 2025, subject to the conditions of approval, and all applicable laws, ordinances, and regulations. Any proposed non-substantial deviations, changes, or modifications will be subject to the Zoning Manager's review and approval. Any proposed substantial deviations, changes, or modifications will be subject to a public hearing before the Board of Zoning Adjustment (BZA) where the BZA makes a recommendation to the Board of County Commissioners (BCC).
2. Pursuant to Section 125.022, Florida Statutes, issuance of this development permit by the County does not in any way create any rights on the part of the applicant to obtain a permit from a state or federal agency and does not create any liability on the part of the County for issuance of the permit if the applicant fails to obtain requisite approvals or fulfill the obligations imposed by a state or federal agency or undertakes actions that result in a violation of state or federal law. Pursuant to Section 125.022, the applicant shall obtain all other applicable state or federal permits before commencement of development.
3. Any deviation from a Code standard not specifically identified and reviewed/addressed by the Board of County Commissioners shall be resubmitted for the Board's review or the plans revised to comply with the standard.

C: Ryan Erickson  
806 E. South St.  
Orlando, Florida 32801

---

**COVER LETTER**

---

8 January 2025

From: Ryan Erickson  
To: Orange County Board of Zoning Adjustment & Board of County Commissioners

Subj: VARIANCE REQUEST – 1600 JESSAMINE AVENUE

Encl: (1) Variance Application  
(2) Survey  
(3) Site Plan  
(4) Floor Plans  
(5) Elevation  
(6) Pell Family Trust  
(7) Pell Family Trust Amendment

This request is for a variance from the zoning code requirement of a minimum lot width of 75 feet in order to build on a R-1A lot. I am under contract to purchase 1600 Jessamine Avenue, Orlando, FL 32806. My lender requires an approved variance to build on the lot in order for me to close on my loan to purchase the property.

The lot was 50 feet wide when initially plotted. The subject lot and the adjoining lot to the north were under common ownership after 7 October 1957. The width of the subject lot was subsequently increased to 60 feet in 1973 when the owner sold a portion of the adjoining lot on the north side along with the subject lot. There was previously a house on the subject lot which was demolished.

I am seeking to build a single-family home with an accessory dwelling unit on the lot. This home will be my primary residence. The planned structure will comply with all zoning code requirements other than the 75-foot lot width requirement. The exterior walls of the structure will be concrete block on the first floor and wood frame on the second floor. The structure will be 3,007 square feet under air, and 4,245 square feet total. The structure will be 8 feet 9 inches from the north side property line, seven feet six inches from the south side property line, 25 feet from the east front property line, and 36 feet 8 inches from the west rear property line. The highest point of the structure will be 25 feet 3 inches tall. The dimensions are detailed in the attached Site Plan and Floor Plans.

This request meets the six standards for variance approval, as also explained in the Variance Application:

1. **Special Conditions and Circumstances.** This lot was plotted prior to the existence of the zoning code. It was 50 feet wide when plotted and was subsequently increased to 60 feet. There was previously a house on this lot. Most other lots on Jessamine Avenue are narrower than this lot and have a house.
2. **Not Self-Created.** The above special conditions and circumstance do not result from my actions. This lot has always been less than 75 feet wide.
3. **No Special Privilege Conferred.** Approval of this zoning variance request will not confer any special privilege to me. This lot has always been less than 75 feet wide. There

---

**COVER LETTER**

---

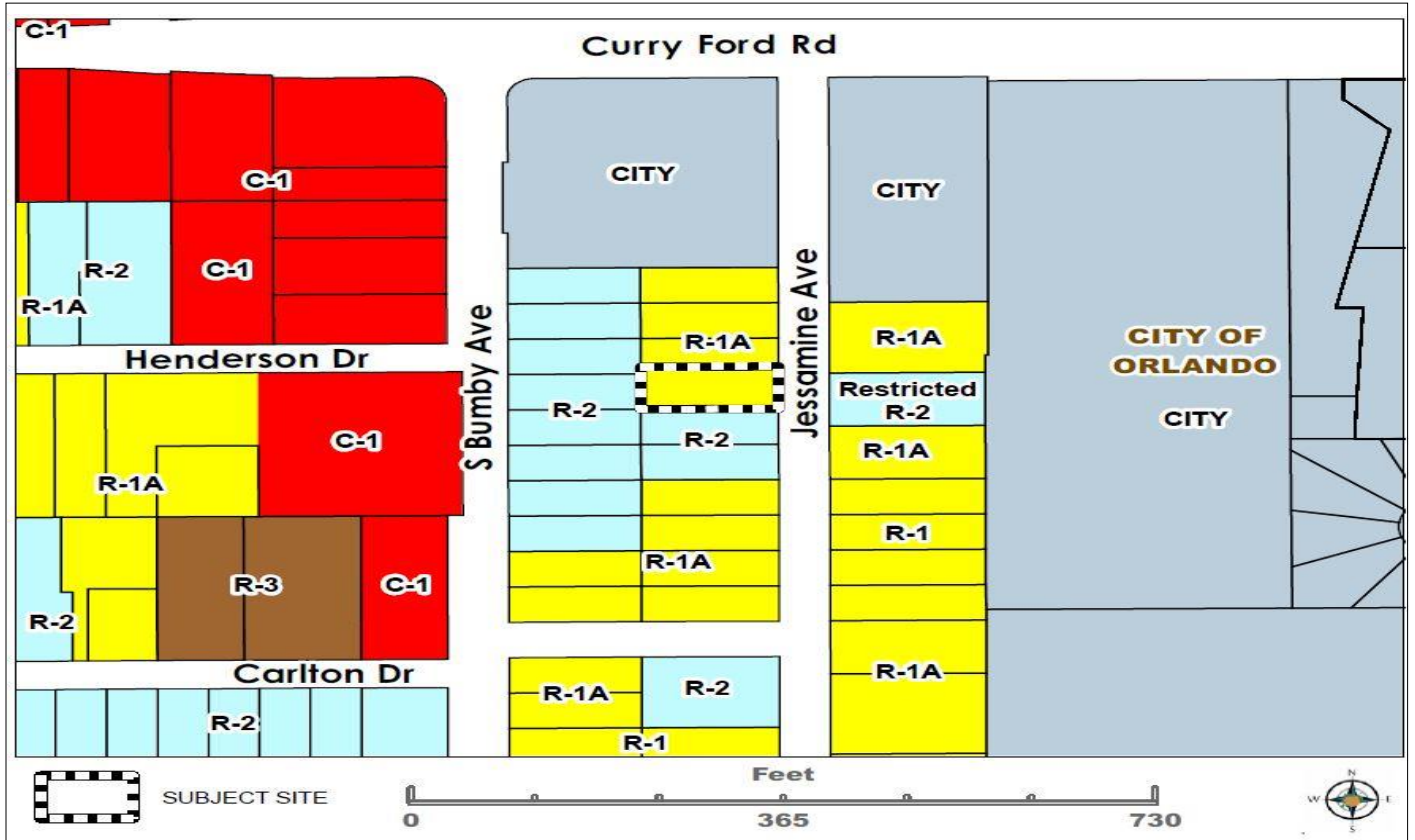
- was previously a house on this lot. Most other lots on Jessamine Avenue are narrower than this lot and have a house. There are houses on every lot that adjoins this lot.
4. **Deprivation of Rights.** Denial of this variance request would deprive me of rights commonly enjoyed by other properties in the same zoning district. I cannot build a home on this lot without this variance. Most other lots on Jessamine Avenue are narrower than this lot and have a house. There are houses on every lot that adjoins this lot.
  5. **Minimum Possible Variance.** The requested variance is the minimum variance that will make use of the land possible. The lot is intended for residential use, but the code at issue makes residential use impossible. The attached Site Plan complies with all zoning code requirements other than the 75-foot lot width requirement.
  6. **Purpose and Intent.** Approval of this variance request will be in harmony with the purpose of intent of the Zoning Regulations and will not be injurious to the neighborhood or otherwise detrimental to the public welfare. Most other lots on Jessamine Avenue are narrower than this lot and have a house. Granting this variance request, which will allow me to build a house on this lot, will result in use of the lot in harmony with the intent of a R1A lot and the neighborhood.

I am requesting only a variance from the minimum lot width requirement so that I can build a home on a lot that previously had a home erected on it.

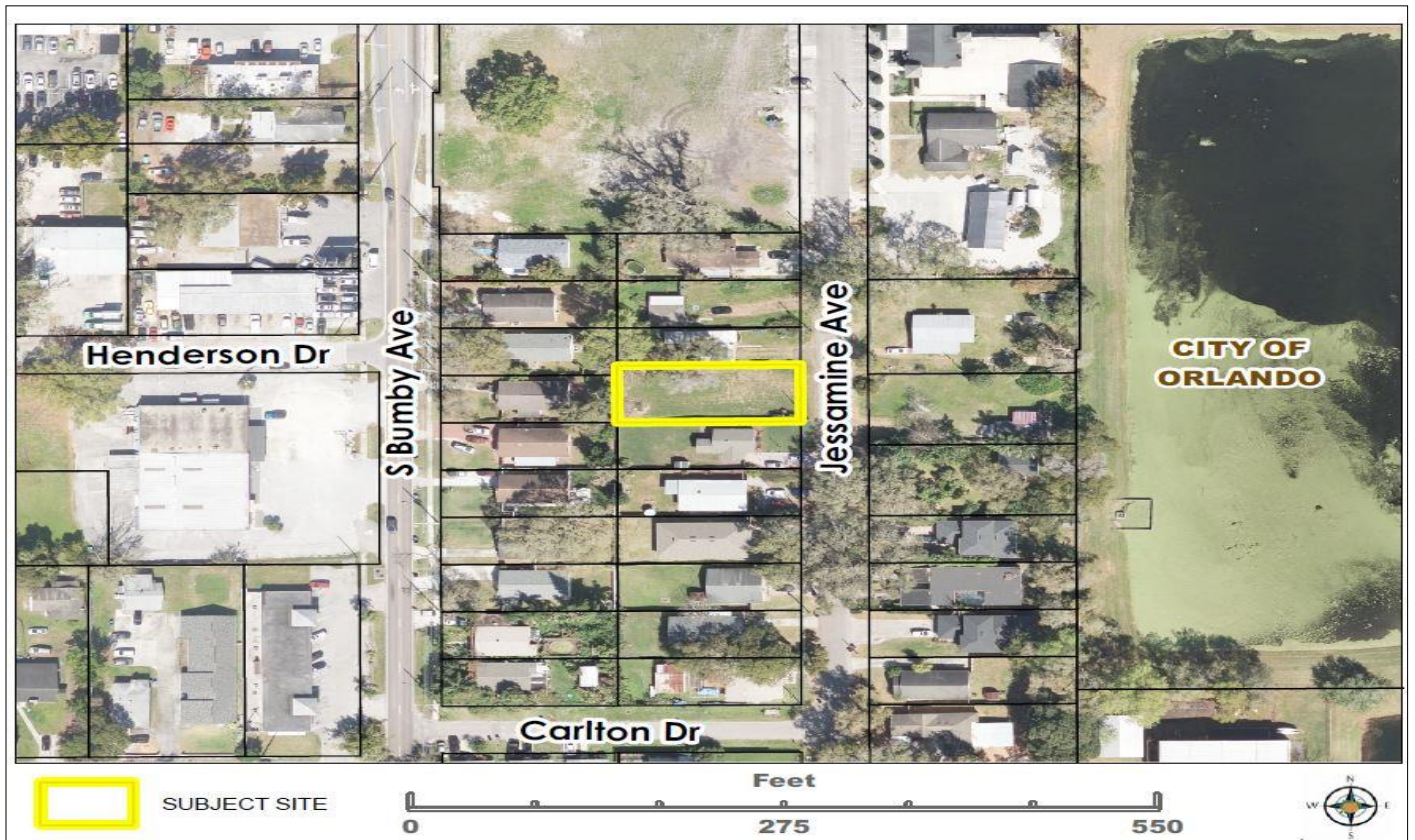
Thank you for your time and consideration of this matter.

/s/  
Ryan Erickson

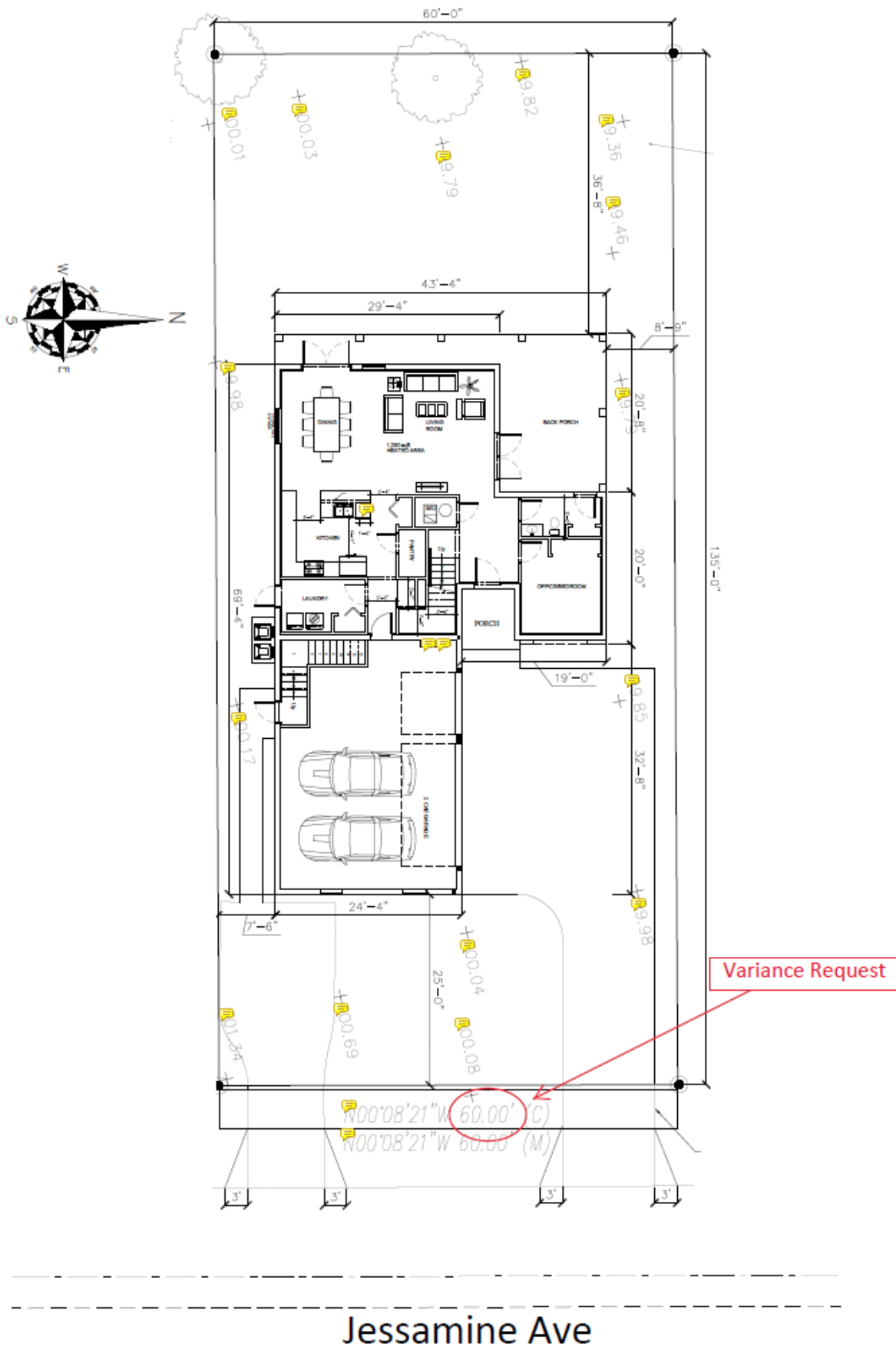
ZONING MAP



AERIAL MAP



SITE PLAN





**SITE PHOTOS**



**Facing west towards front of subject property from Jessamine Ave.**



**Facing northeast towards the neighboring property to the north**

**SITE PHOTOS**



**Facing southwest towards the neighboring property to the south**



**Facing east from the subject lot towards Jessamine Ave.**

# BZA STAFF REPORT

Planning, Environmental & Development Services/ Zoning Division

Meeting Date: **APR 03, 2025**

Commission District: **#2**

Case #: **VA-25-04-004**

Case Planner: **Jenale Garnett (407) 836-5955**

**Jenale.Garnett@ocfl.net**

## GENERAL INFORMATION

**APPLICANT(s):** LUCAS FOWLER

**OWNER(s):** RACHEL TYBOR, LUCAS FOWLER

**REQUEST:** Variances in the R-CE zoning district as follows:

- 1) To allow an addition (screen room) with an east front setback of 27 ft. in lieu of 35 ft.
- 2) To allow an existing residence with a north side setback of 4.3 ft. in lieu of 10 ft.
- 3) To allow an existing addition with a west rear setback of 24 ft. in lieu of 50 ft.

**PROPERTY LOCATION:** 5316 Roan Rd., Apopka, Florida 32712, west side of Roan Rd., east of Mt. Plymouth Rd., north of W. Kelly Park Rd., south of the Lake County line

**PARCEL ID:** 09-20-28-7264-04-050

**LOT SIZE:** +/- 0.23 acres (+/- 10,106 sq. ft.)

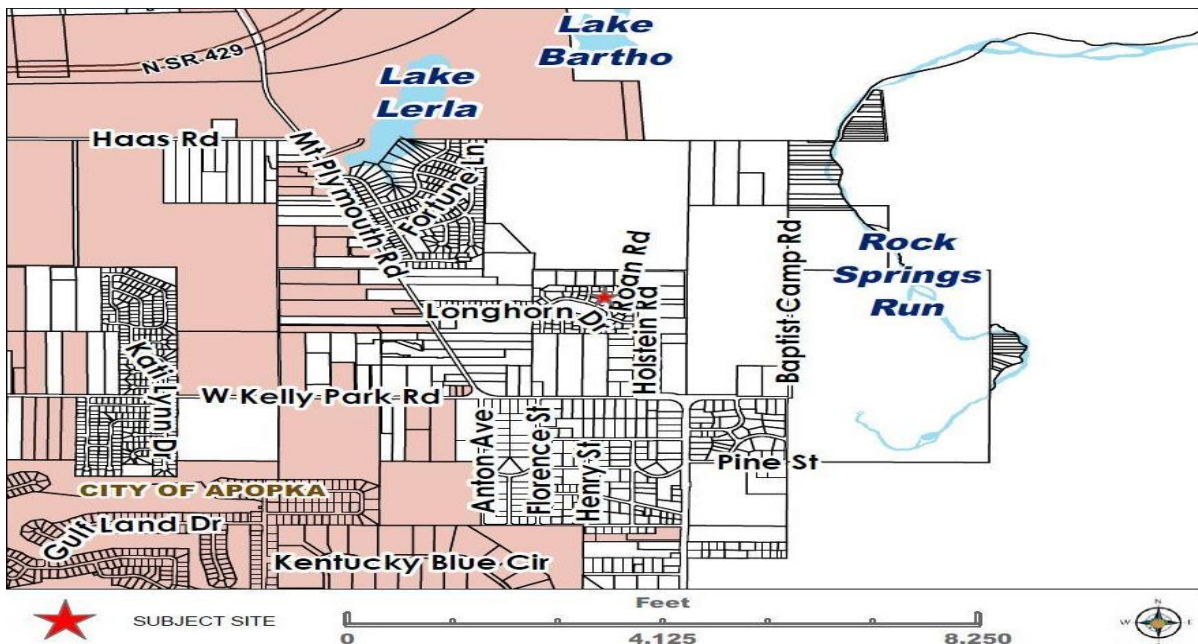
**NOTICE AREA:** 500 ft.

**NUMBER OF NOTICES:** 62

## STAFF RECOMMENDATIONS

Approval of Variances #1 and #2, and approval of a lesser Variance #3 of 30 ft. in lieu of 50 ft., subject to the conditions in this report. However, if the BZA should find that the applicant has satisfied the criteria for the granting of all of the Variances, staff recommends that the approval be subject to the conditions in this report.

## LOCATION MAP



---

**SITE & SURROUNDING DATA**

---

	Property	North	South	East	West
Current Zoning	R-CE	R-CE	R-CE	R-CE	R-CE
Future Land Use	LDR	LDR	LDR	LDR	LDR
Current Use	Single-family residence	Single-family residence	Single-family residence	Single-family residence	Single-family residence

---

**BACKGROUND AND ANALYSIS**

---

**DESCRIPTION AND CONTEXT**

The subject property is located in the R-CE, Rural Country Estate District, which allows for single family development on one (1) acre lots and certain rural uses. The future land use is Low Density Residential (LDR), which is inconsistent with the R-CE zoning district outside of Rural Settlements or Rural Residential Enclaves. A Comprehensive Plan amendment is not required for a single residential unit on a lot of record. Comprehensive Plan Policy FLU1.1.3B. allows for *the construction of one (1) residential unit (including ancillary buildings or improvements) on an existing lot of record (according to Zoning Division records) as of July 1, 1991.* Comprehensive Plan Policy FLU1.1.2 sets the residential densities permitted within the Urban Service Area and requires properties within the Low Density Residential (LDR) future land use designation to be a minimum of 0.25 acres. This lot is considered a lot of record, having been platted prior to the adoption of the Comprehensive Plan on July 1, 1991.

The subject property is a +/- 10,106 sq. ft. lot with a lot width of 100 ft., platted in 1954 as Lot 5 of the Pro's Ranch plat, and is a substandard lot of record. The property was previously zoned as R-1, Single-Family Dwelling District, and met the required minimum lot width of 50 ft., minimum lot area of 5,000 sq. ft., and 30 ft. rear setback. In 1981, the property went through an administrative rezone to R-CE. The area surrounding the subject site consists of single-family homes. The property is developed with a one-story 1,680 gross sq. ft. single-family home constructed in 1973. Improvements to the property include a 147.6 sq. ft. addition of living area that appears via aerial imagery in 2011, and a 72 sq. ft. covered patio that appears in 2015. Both improvements were installed without permits. The property was purchased by the current owners in 2018.

The proposal is for the construction of a 312 sq. ft., 12.7 ft. tall screen room addition to the front of the existing residence with an east front setback of 27 ft. in lieu of 35 ft., requiring Variance #1. A permit, B24022497, to construct a screen room is on hold pending the outcome of this request. The existing residence has a non-conforming north side setback of 4.3 ft. in lieu of the required 10 ft., requiring Variance #2 to recognize the existing condition. Additionally, the existing living area and covered patio additions built without permits are proposed to remain with a west rear setback of 24 ft. in lieu of 50 ft., necessitating the need for Variance #3.

Section 30-43 (3) of the Orange County Code stipulates a recommendation of approval can only be made if all six (6) Variance criteria are met. Staff has determined that Variances #1 and #2 meet all the criteria. The existing residence's footprint in relation to the front line and the location of the septic tank and drainfield limits the area a useable addition or improvements could be constructed without a Variance. Variance #2 would recognize the existing location of the residence as originally built, which has been in the same location for over 52 years. Therefore, staff is recommending approval of the Variances #1 and #2 requests.

However, while the Variance #3 request meets some of the standards for Variance criteria, it does not meet all of them. Therefore, staff is recommending a lesser Variance #3 of 30 ft. instead of the requested 24 ft. in lieu of 50 ft. as the minimum possible request for the Variance #3. Based on staff analysis, the 12 ft. by 6 ft. covered patio could be removed to lessen the request since the owner is not being deprived of a patio as there is another patio located at the rear of the existing residence.

The request was routed to all reviewing divisions and no objections were provided. As of the date of this report, four comments have been received in favor of this request and no comments have been received in opposition to this request.

### District Development Standards

	Code Requirement	Proposed
Max Height:	35 ft.	12.7 ft. (proposed addition)
Min. Lot Width:	130 ft.	100 ft.
Min. Lot Size:	43,560 sq. ft.	10,106 sq. ft.

### Building Setbacks

	Code Requirement	Proposed
Front:	35 ft.	27 ft. proposed addition (East – Variance #1)
Rear:	50 ft.	30 ft. existing residence (West) 24 ft. existing addition/covered patio (West – Variance #3)
Side:	10 ft.	4.3 ft. existing residence (North – Variance #2) 39.4 existing residence (South) 39.4 ft. existing addition/covered patio (South)

---

## STAFF FINDINGS

---

### VARIANCE CRITERIA

#### Special Conditions and Circumstances

MET – Pertaining to Variances #1 and #3 the special condition and circumstance particular property are related to existing residence’s footprint in relation to the front and rear property line, and the location of the drainfield and septic tank which limits the area a useable addition or improvements could be constructed without a Variance. Further pertaining to Variance #2, the special condition and circumstance particular to the subject property is the existing residence being constructed in a location that was compliant with the Code at that time, but does not conform to the R-CE requirements.

#### Not Self-Created

MET – **Variances #1 and #2:** The need for Variance #1 is not self-created as the location of the existing residence, septic tank, and drainfield renders it difficult to make any addition or improvements to the existing residence that would meet code. The request for Variance #2 is not self-created since the owner is not responsible for the existing location of the residence.

NOT MET – **Variance #3:** The request is self-created since there are options available such as a lesser Variance by removing the covered patio.

MET - **Lesser Variance #3:** Pertaining to Variance #3, the approval of the lesser Variance would allow for an improvement with a similar setback as the existing residence. Further, the septic tank, drainfield, and placement of the existing residence renders it difficult to make any addition or improvement that would meet code.

### **No Special Privilege Conferred**

MET – Granting the Variances #1 and #3 as requested would not confer special privilege as several other properties in the area appear to have similar approved requests for additions relative to the front and rear property lines. Further, the owner will be deprived of the ability to construct improvements to the existing residence due to the orientation and configuration of the residence in relation to the front property line. Further, granting the requested Variance #2 will not confer any special privilege conferred to others under the same circumstances.

### **Deprivation of Rights**

MET – Denial of the requested Variance #1 and approval of a lesser Variance #3 would deprive the owners the ability to enjoy improvements to the existing residence since the existing residence, septic tank, and drainfield renders it difficult to make any addition or improvements that would meet code. Approval of Variance #2 will allow the recognition of the existing location of the existing residence for over 52 years.

### **Minimum Possible Variance**

MET – **Variances #1 and #2:** Due to the existing non-conforming setbacks and the location of the improvements, the requested Variances are the minimum possible.

MET - **Lesser Variance #3:** The requested Variance for the existing addition is not the minimum possible since the covered patio could be removed to lessen the requested setback Variance from a setback of 24 ft. to 30 ft.; the proposed lesser Variance is the minimum possible.

### **Purpose and Intent**

MET – Approval of the requested Variances would be in harmony with the purpose and intent of the Zoning Regulations as the code is primarily focused on minimizing the impact that structures have on surrounding properties. The proposed addition at the front of the residence will have similar setbacks to several other properties with approved requests in the surrounding area. Further, the existing addition at the rear of the residence will not be significantly visible from any surrounding properties due the 6 ft. wood fence and existing vegetation surrounding the property, thereby limiting any quantifiable negative impact to surrounding property owners. Approval of the requested Variance #2 would be in harmony with the purpose and intent of the Code since the request will recognize the existing non-conforming setback of the residence.

---

## CONDITIONS OF APPROVAL

---

1. Development shall be in accordance with the site plan dated January 3, 2025, as modified reflect the lesser rear yard setback Variance of 30 ft., subject to the conditions of approval, and all applicable laws, ordinances, and regulations. Any proposed non-substantial deviations, changes, or modifications will be subject to the Zoning Manager's review and approval. Any proposed substantial deviations, changes, or modifications will be subject to a public hearing before the Board of Zoning Adjustment (BZA) where the BZA makes a recommendation to the Board of County Commissioners (BCC).
2. Pursuant to Section 125.022, Florida Statutes, issuance of this development permit by the County does not in any way create any rights on the part of the applicant to obtain a permit from a state or federal agency and does not create any liability on the part of the County for issuance of the permit if the applicant fails to obtain requisite approvals or fulfill the obligations imposed by a state or federal agency or undertakes actions that result in a violation of state or federal law. Pursuant to Section 125.022, the applicant shall obtain all other applicable state or federal permits before commencement of development.
3. Any deviation from a Code standard not specifically identified and reviewed/addressed by the Board of County Commissioners shall be resubmitted for the Board's review or the plans revised to comply with the standard.
4. Prior to the issuance of a permit for the proposed addition (screen room), a permit for the existing addition shall be obtained or it shall be removed.
5. Prior to the issuance of a permit for the proposed addition (screen room), a demolition permit shall be obtained and finalized for the rear covered patio.

C: Lucas Fowler  
5316 Roan Road  
Apopka, Florida 32712

---

**COVER LETTER**

---

RE: VARIANCE APPLICATION

5316 Roan Rd.

Apopka, FL 32712

To whom it may concern:

This request is for an 8-foot variance into the front yard to allow us to build a 26' x 12' (312sqft.) screen room on a proposed concrete slab. The structure will be no taller than 9'1" and is currently 27' from the **front property line.**, 40.5" from the left yard setback, and 15.6' from the right yard setback.

This proposal meets the six standards for variance approval as outlined below:

1. **Special Conditions and Circumstances** – The front yard setback takes up nearly 35% of the total property length leaving very little room for improvement in the front yard.
2. **Not Self-Created** – The orientation and distance from the front property line was not determined by the homeowner. There is little to no space, with respect to the front property setback, for improvement.
3. **No Special Privilege Conferred** – There will be no special privilege conferred.
4. **Deprivation of Rights** – The literal interpretation of the zoning code would deprive me from improving, not only my property, but the enjoyment of an outdoor living space.
5. **Minimum Possible Variance** – The 8-foot variance is the minimum required to build the proposed structure.
6. **Purpose and Intent** – This variance will not interfere with section 38-1601 Intent and Purposes. The screen room will not impede circulation of air, natural light, access for fire-fighting apparatus or rescue and salvage operations while maintaining adequate and safe distances from associated major streets, buildings, and structures.

Kind Regards,

Lucas Andrew Fowler and Rachel Marie Tybor

4316 Roan Rd.

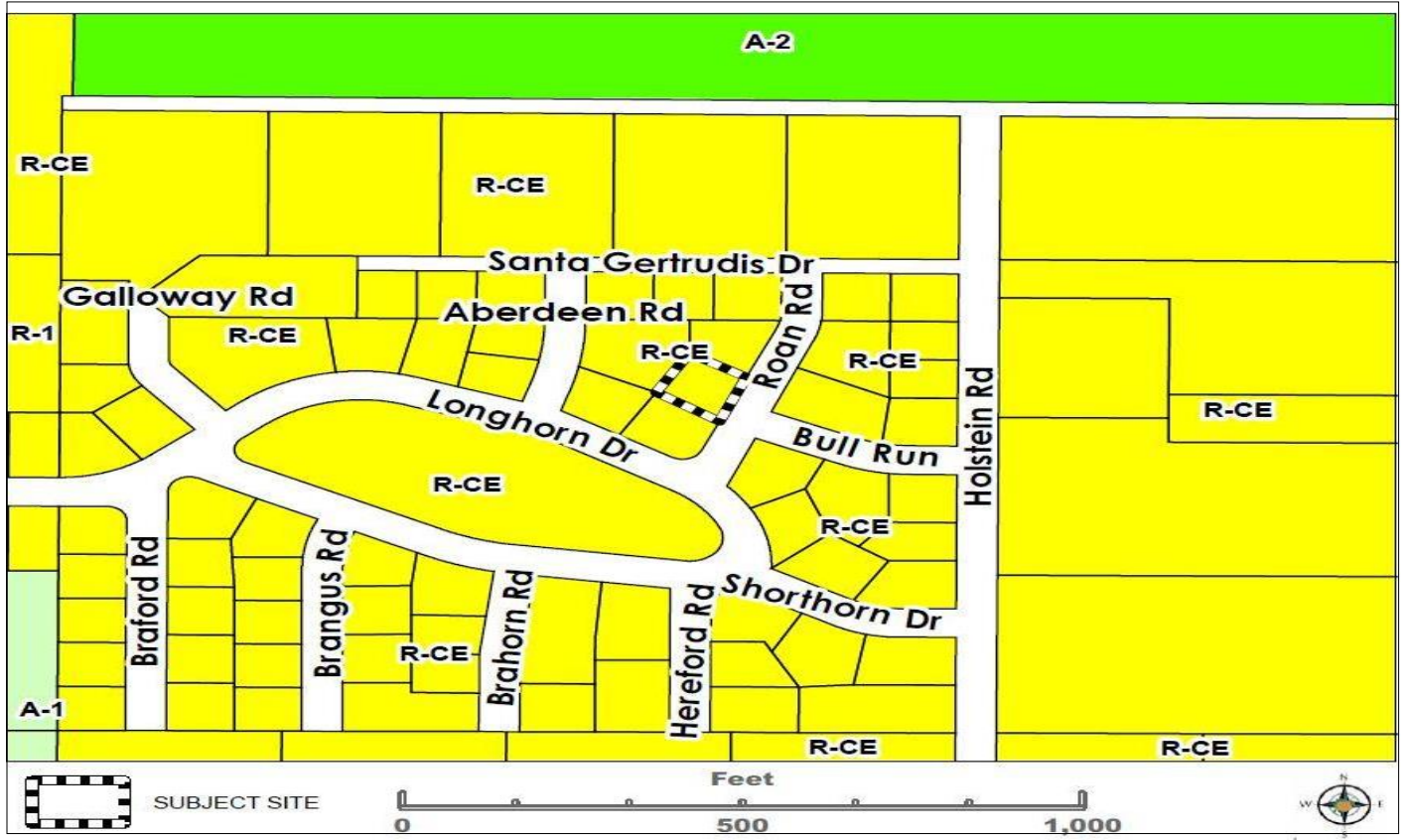
Apopka, FL 32712

(P) 786-918-2774

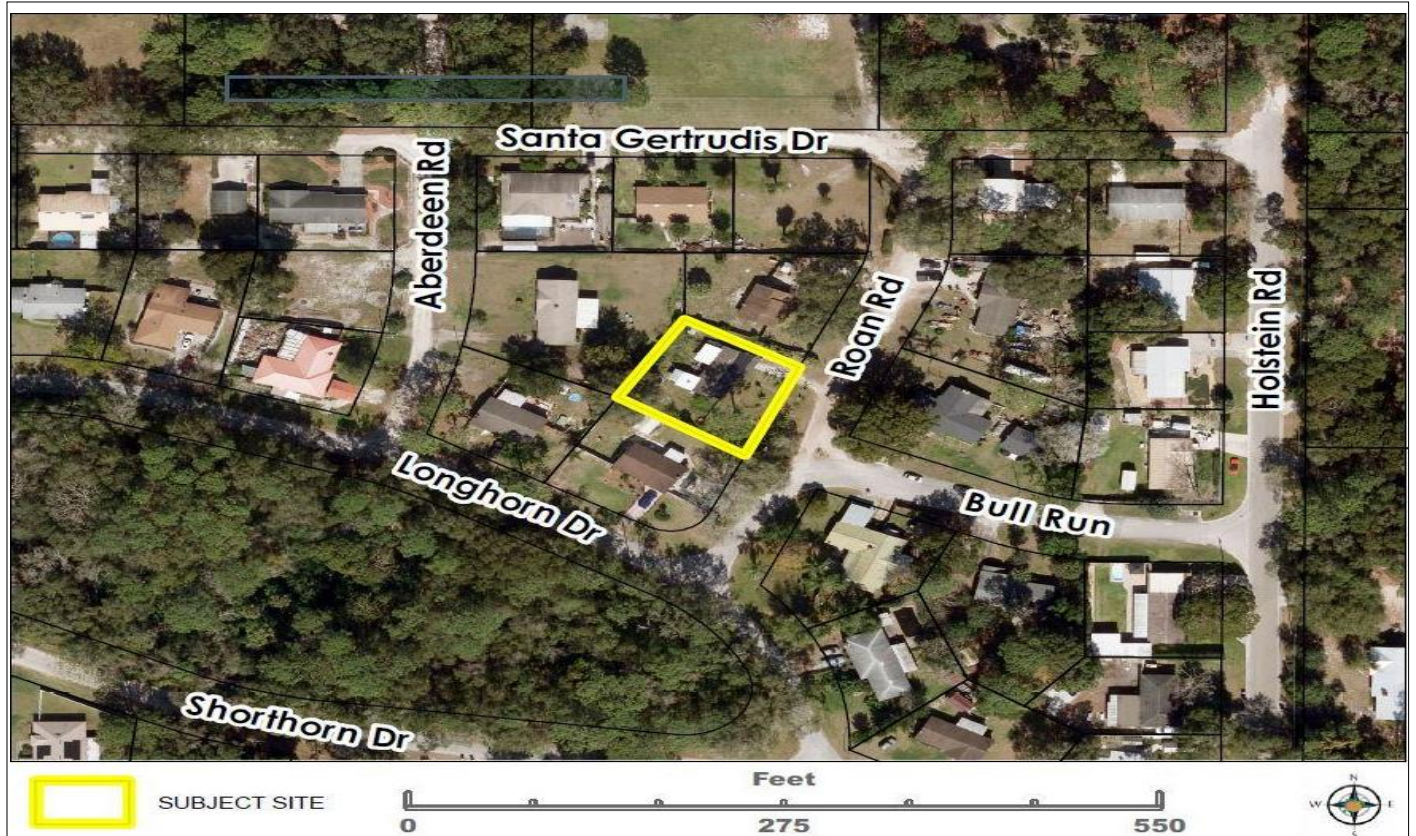
(E) fowler.lucas@gmail.com



ZONING MAP



AERIAL MAP



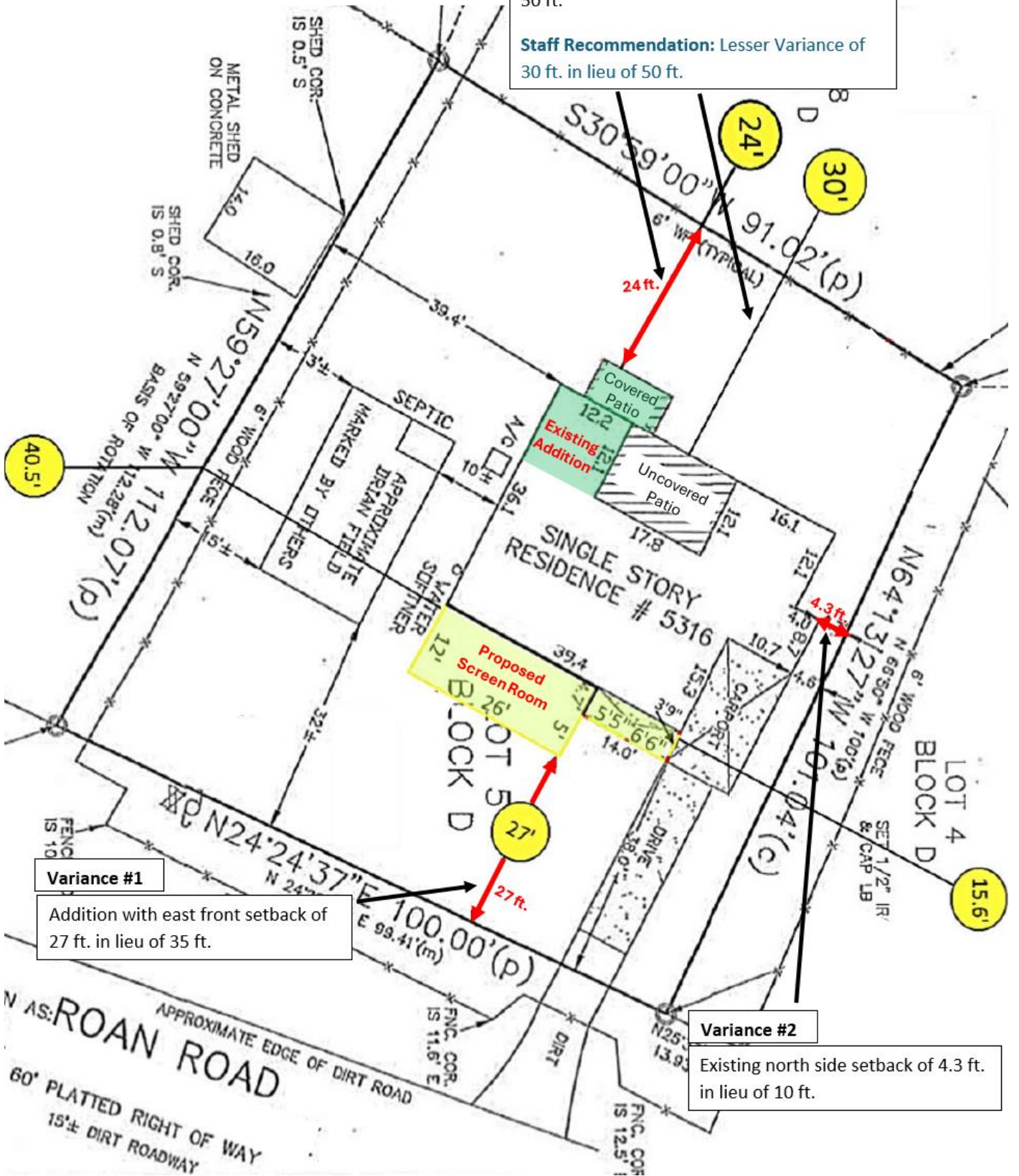
SITE PLAN



Variance #3

Existing west rear setback of 24 ft. in lieu of 50 ft.

**Staff Recommendation:** Lesser Variance of 30 ft. in lieu of 50 ft.



Variance #1

Addition with east front setback of 27 ft. in lieu of 35 ft.

Variance #2

Existing north side setback of 4.3 ft. in lieu of 10 ft.

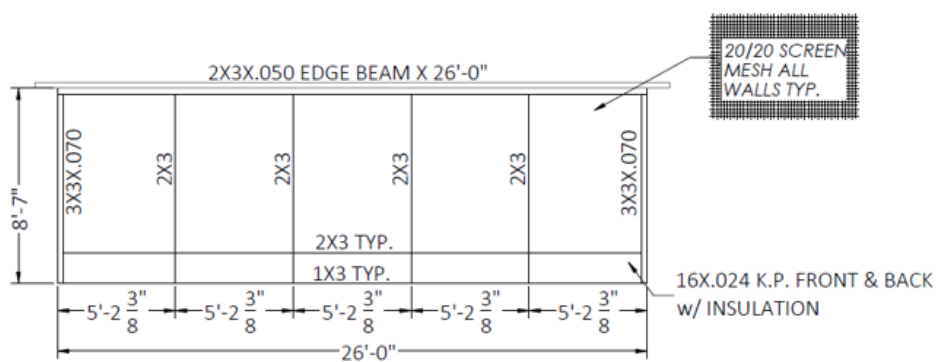
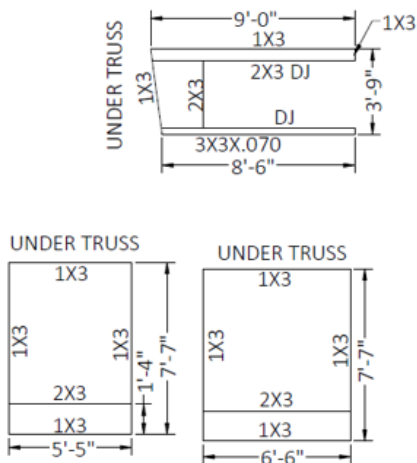
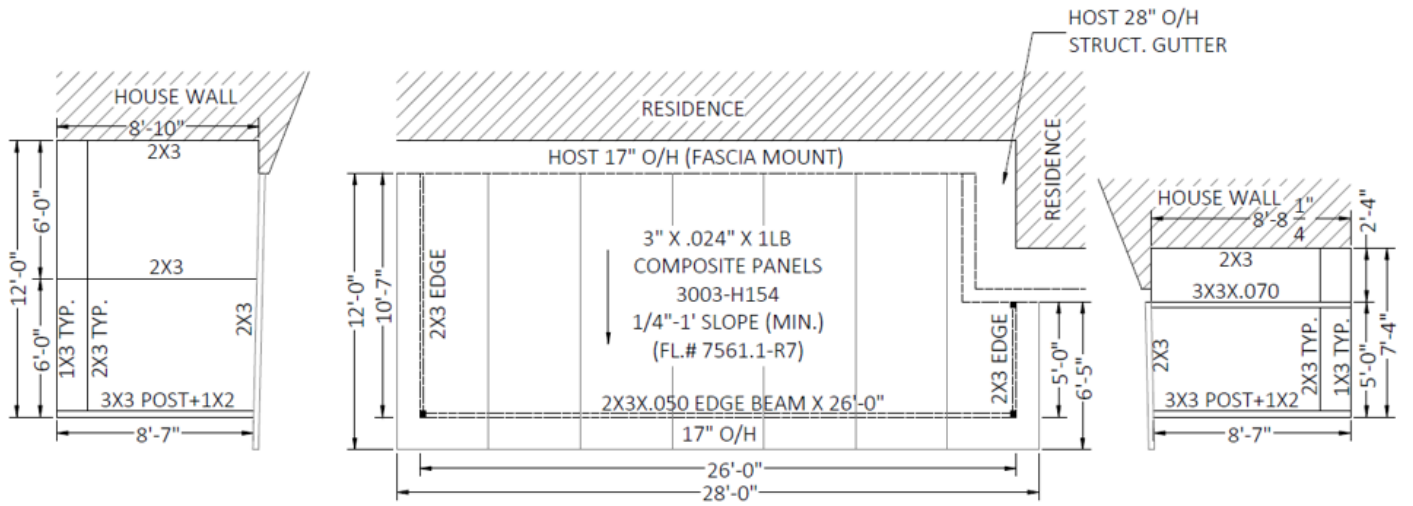
# SPECIFICATIONS FOR PROPOSED SCREEN ROOM

## HATCH/ SYMBOL LEGEND

HATCH	INDICATES
	EXIST. STRUCTURE

NOTE: ALL MAY NOT APPLY

■ = 3X3X.070



**PROPOSED MONOSLOPE SCREEN ROOM**

**SITE PHOTOS**



**Facing northwest from Roan Rd. towards the subject property**

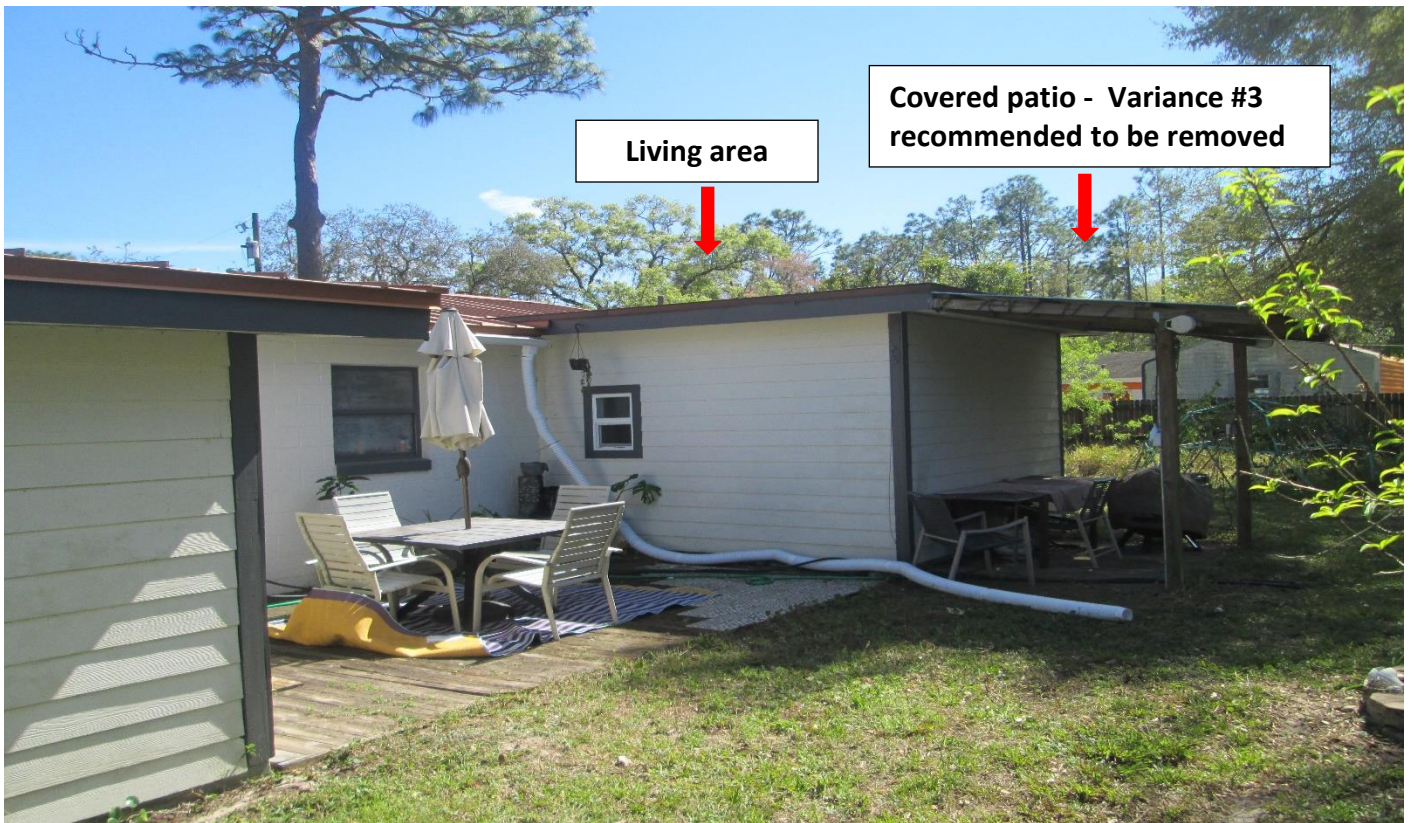


**Front yard, facing northeast from corner of existing residence towards proposed screen room location**

**SITE PHOTOS**



**Rear yard, facing northeast towards existing rear of residence**



**Rear yard, facing south towards unpermitted existing addition to remain**

**SITE PHOTOS**



**Rear yard, facing west towards Variance #3 request**



**Rear yard, facing northeast towards Variance #2 request**

# BZA STAFF REPORT

Planning, Environmental & Development Services/ Zoning Division

Meeting Date: **APR 03, 2025**

Commission District: **#1**

Case #: **VA-25-04-006**

Case Planner: **Jenale Garnett (407) 836-5955**  
**Jenale.Garnett@ocfl.net**

## GENERAL INFORMATION

**APPLICANT(s):** LOUIS SENNEVILLE

**OWNER(s):** LOUIS SENNEVILLE, EUGENIA SENNEVILLE

**REQUEST:** Variances in the A-1 zoning district as follows:

- 1) To allow an existing detached accessory structure (shed) with an east side setback of 4.4 ft. in lieu of 5 ft.
- 2) To allow an existing detached accessory structure (shed) with a Normal High Water Elevation (NHWE) setback of 19.2 ft. in lieu of 50 ft.
- 3) To allow an existing residence with a Normal High Water Elevation (NHWE) setback of 23.8 ft. in lieu of 50 ft.

Note: This is a result of Code Enforcement.

**PROPERTY LOCATION:** 6534 Sawyer Shores Ln., Windermere, Florida 34786, south side of Sawyer Shores Ln., east of Lake Sawyer, south and west of Winter Garden Vineland Rd.

**PARCEL ID:** 24-23-27-7820-01-040

**LOT SIZE:** +/- 0.38 acres (+/- 0.30 acres upland)

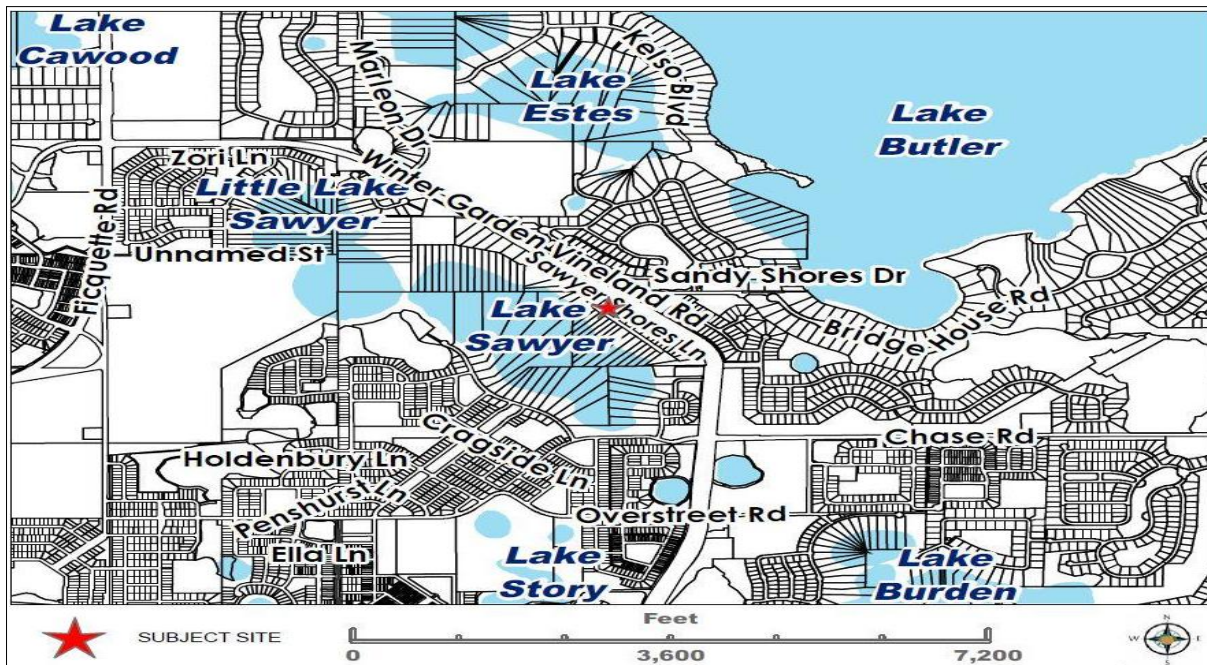
**NOTICE AREA:** 500 ft.

**NUMBER OF NOTICES:** 49

## STAFF RECOMMENDATIONS

Approval, subject to the conditions in this report.

## LOCATION MAP



---

**SITE & SURROUNDING DATA**

---

	Property	North	South	East	West
Current Zoning	A-1	Islesworth West PD & Waterstone PD	A-1	A-1	A-1
Future Land Use	Village	Rural 1/1 (West Windermere Rural Settlement)	Village	Village	Village
Current Use	Single-family residence	Vacant/Retention	Canal, Lagoon St.	Single-family residence	Single-family residence

---

**BACKGROUND AND ANALYSIS**

---

**DESCRIPTION AND CONTEXT**

The subject property is located in the A-1, Citrus Rural zoning district, which primarily allows agricultural uses, as well as mobile homes and single-family homes on larger lots. The future land use is Village (V), which is consistent with the zoning district for a single-family home on a lot of record.

The area surrounding the subject site consists of single-family homes that run along a canal. The subject property is a +/- 0.38 acre lot located on the north side of the canal, of which +/- 0.30 acres is upland. The property is Lot 4 of the Sawyer Shores Subdivision, platted in 1956, and is considered to be a substandard lot of record. It is a double frontage or through lot with a frontage on both Sawyer Shores Lane and Lagoon Street. Per Sec. 38-1405(d), *on double frontage lots, unless otherwise determined by the Zoning Manager the required front yard shall be provided on each street; except that when all lots in the block have been or will be developed with all of the buildings facing the same street, the second frontage of those lots shall be designated and utilized as rear yard.* All lots along this block have been developed facing Sawyer Shores Ln., making this the front, and Lagoon St. the rear.

The property is developed with a one-story 2,239 gross sq. ft. single-family home constructed in 1981, with a 560 sq. ft. attached carport (B23005747) built in 2023. Additional improvements include a 272 sq. ft. addition (screened porch) and 161 sq. ft. detached accessory structure (shed). No record of permits for the improvements are available and the year of installation cannot be ascertained via aerial and street view photography due to heavy vegetation. The owner states the addition was built in the 1980's and the shed installed in 2013. The property was purchased by the current owners in 1981.

Code compliance cited the property owner on October 11, 2024 (CE#: 646415) for a shed and carport installed without permits. After review, the carport was found to be permitted. Following the citation, a permit was submitted for the existing shed (B24020540), which is on hold pending the outcome of this case.

The proposal is to allow the existing 16.1 ft. by 10 ft., 10.3 ft. tall shed installed without permits to remain with an east side setback of 4.4 ft. in lieu of 5 ft., and to be located 19.2 ft. from the Normal High Water Elevation (NHWE) in lieu of 50 ft., requiring Variances #1 and #2 respectively. Additionally, the residence has a non-conforming setback of 23.8 ft. from the NHWE in lieu of 50 ft., requiring Variance #3 to recognize the existing condition.



Section 30-43 (3) of the Orange County Code stipulates a recommendation of approval can only be made if all six (6) Variance criteria are met. Staff has determined that all the Variances meet all the criteria for a recommendation of approval. The location of the existing residence and shed in relation to the canal on the south side of the property renders the construction of any addition or improvements difficult without Variances. Further, there is limited space to relocate the shed to meet code due to the location of the well and septic tank. The approval would also allow for the recognition of the existing location of the residence since at least 1981. Additionally, the structures are screened from view from the surrounding properties due to the existing vegetation in the rear of the property and the east side of the existing shed location.

The request was routed to all reviewing divisions and no objections were provided. As of the date of this report, five comments have been received in favor of this request and no comments have been received in opposition to this request.

### District Development Standards

	Code Requirement	Proposed
Max Height:	35 ft. 25 ft. (detached accessory structure)	14 ft. 10.3 ft. (shed)
Min. Lot Width:	100 ft.	92 ft.
Min. Lot Size:	1/2 acre	0.38 acres (0.3 acres upland)

### Building Setbacks

	Code Requirement	Proposed
Front (Sawyer Shores Ln.):	35 ft.	73.4 ft. residence (North)
Side:	10 ft. 5 ft. (detached accessory structure)	20 ft. residence (West) 23.2 ft. residence (East) 4.4 ft. shed (East – Variance #1)
NHWE:	50 ft.	23.8 ft. residence (South – Variance #3) 19.2 ft. shed (South – Variance #2)

---

## STAFF FINDINGS

---

### VARIANCE CRITERIA

#### Special Conditions and Circumstances

MET – The special condition and circumstance particular to the subject property is the placement of the existing residence in relation to the canal south of the property, rendering any addition or improvements difficult without Variances. Further, there is limited space due to the location of the well and septic tank to relocate the shed to a Code compliant location. Also, it would recognize the existing location of the residence since at least 1981.

**Not Self-Created**

MET – The request is not self-created since the owner is not responsible for the constraints of the NHWE line due to the canal south of the property, which renders any addition and improvement difficult without Variances. Additionally, there is limited space for the relocation of the existing shed to meet code due to the location of the well and septic tank.

**No Special Privilege Conferred**

MET – Due to the orientation of the existing residence and accessory structure, granting the requested Variances will not confer any special privilege conferred to others under the same circumstances.

**Deprivation of Rights**

MET – Without approval of the requested Variances #1 and #2, the owner will be deprived of the ability to have any accessory structure since there is limited space available to meet code. Approval of Variance #3 will allow the recognition of the existing location of the existing residence to remain.

**Minimum Possible Variance**

MET – Pertaining to Variance #1, due to the location of the septic tank and well limits the space for relocation of the existing shed to meet code, the Variance is the minimum possible. Pertaining to Variances #2 and #3, the placement of the existing residence in relation to the canal south of the property, renders any addition or improvements difficult without Variances.

**Purpose and Intent**

MET – Approval of the requests will be in harmony with the purpose and intent of the Code since the request will allow the existing orientation of the residence and the accessory structure setback from the NHWE to remain. Furthermore, the accessory structure and rear of the residence will not be significantly visible from any surrounding properties due the existing vegetation surrounding the property, thereby limiting any quantifiable negative impact to surrounding property owners.

---

## CONDITIONS OF APPROVAL

---

1. Development shall be in accordance with the site plan date stamped March 6, 2025, and elevations date stamped February 27, 2025, subject to the conditions of approval, and all applicable laws, ordinances, and regulations. Any proposed non-substantial deviations, changes, or modifications will be subject to the Zoning Manager's review and approval. Any proposed substantial deviations, changes, or modifications will be subject to a public hearing before the Board of Zoning Adjustment (BZA) where the BZA makes a recommendation to the Board of County Commissioners (BCC).
2. Pursuant to Section 125.022, Florida Statutes, issuance of this development permit by the County does not in any way create any rights on the part of the applicant to obtain a permit from a state or federal agency and does not create any liability on the part of the County for issuance of the permit if the applicant fails to obtain requisite approvals or fulfill the obligations imposed by a state or federal agency or undertakes actions that result in a violation of state or federal law. Pursuant to Section 125.022, the applicant shall obtain all other applicable state or federal permits before commencement of development.
3. Any deviation from a Code standard not specifically identified and reviewed/addressed by the Board of County Commissioners shall be resubmitted for the Board's review or the plans revised to comply with the standard.
4. Prior to the issuance of any building permit, the property owner shall record in the official records of Orange County, Florida an Indemnification/Hold Harmless Agreement, on a form provided by the County, which indemnifies Orange County, Florida from any damages and losses arising out of or related in any way to the activities or operations on or use of the Improvement resulting from the County's granting of the Variance requests and, which shall inform all interested parties that the existing detached accessory structure is located no closer than 19.2 feet from the Normal High Water Elevation (NHWE) of the canal and the existing residence is located no closer than 23.8 feet from the Normal High Water Elevation (NHWE) of the canal.

C: Louis Senneville  
6534 Sawyer Shores Lane  
Windermere, Florida 34786

---

## COVER LETTER

---

### Variance Request Cover Letter

To Whom It May Concern:

Greetings!

My name is Louis Senneville and I reside at 6534 Sawyer Shores Ln Windermere, FL 34786.

The Variance Request is for a 10' x 16' Smithbilt Shed the location of which is noted on the included Survey. It has been in that position since 2006 and has been known to the Orange County Property Accessor's office since then.

The shed is a wood-frame covered in Anodized metal with a roll-up door on one end and a standard door in the middle. (See included Architectural drawings)

The shed, in it's current location has met all Orange County building requirements (structural, elevation, termite treatment, storm Water, etc (See Building Permit #B24020540) and has had no negative impact on my property, the adjacent property (See included letter from Rick Corner) or the neighborhood in general.

The location of the shed was necessitated by the fact that any other location would have blocked access to either our well or septic system, required the removal of three mature trees or have a negative impact on my neighbor's view. The shed sits right next to my neighbor's shed and both are covered by landscaping. Also, if one considers the 50' setback from the NHWL (Norma High water Line) and that the shed can not break the plane of the front of the house, no matter where I put the shed, according to the County, I would need a variance.

Many of the houses in the Sawyer Shores neighborhood have backyard structures so I am not asking for any Special Privileges...just the same privilege as my neighbors. I have included letter from all of the neighbors who, if all foliage were removed, could see the shed and no one has a problem with the shed in its current location.

What I am asking for IS the minimum possible variance as nothing else is required.

The purpose of the shed is storage (we have a very small house) and as a workshop for myself. I like to build things and the shed is storage for household goods and my tool collection.

In closing, after doing a lot of research into the Orange County Code, I found the following: 38-1503 - If the plat for the subdivision and the purchase of the property was lawfully recorded before August 31, 1982 and the distance from the property line to the NHWL is less than 150' then the property is exempt from the 50' setback requirement.

The plat for Sawyer Shores Sub-division was recorded on November 20, 1956, the property sale was recorded on February 1, 1981 and the distance from the property line to the NHWL is 146'. If I am interpreting this correctly, a Variance is not necessary...but I could be wrong.

If you have any questions, please feel free to contact me.

Thank-you for your consideration,

Louis A. Senneville  
6534 Sawyer Shores Ln  
Windermere, FL 34786  
[tsenneville@earthlink.net](mailto:tsenneville@earthlink.net)  
407-810-9619

---

**COVER LETTER**

---

**VARIANCE CRITERIA**

1. **Special Conditions and Circumstances** - Special conditions and circumstances exist which are peculiar to the land, structure, or building involved and which are not applicable to other lands, structures or buildings in the same zoning district. Zoning violations or nonconformities on neighboring properties shall not constitute grounds for approval of a proposed zoning variance.

The selected location of the shed was the only location that did not block access to either our well or septic system, did not require the removal of several mature pine trees or become a visual problem for either the neighbor adjacent to the shed or the neighborhood in general.

2. **Not Self-Created** - The special conditions and circumstances do not result from the actions of the applicant. A self-created or self-imposed hardship shall not justify a zoning variance; i.e., when the applicant himself by his own conduct creates the hardship which he alleges to exist, he is not entitled to relief.

If one were to consider the two limiting factors in placing the shed: 50' above the NHWE and not on the plane of the front of the house...there is no where on my property that the shed could be placed.

3. **No Special Privilege Conferred** - Approval of the zoning variance requested will not confer on the applicant any special privilege that is denied by this Chapter to other lands, building, or structures in the same zoning district.

No Special Privilege is requested: most of the houses in the Sawyer Shores Subdivision have backyard structures of various sizes.

4. **Deprivation of Rights** - Literal interpretation of the provisions contained in this Chapter would deprive the applicant of rights commonly enjoyed by other properties in the same zoning district under the terms of this Chapter and would work unnecessary and undue hardship on the applicant. Financial loss or business competition or purchase of property with intent to develop in violation of the restrictions of this Chapter shall not constitute grounds for approval or objection.

As stated above, most of the properties in the Sawyer Shores subdivision have backyard structures of various sizes so I am asking for the same rights as my neighbors.

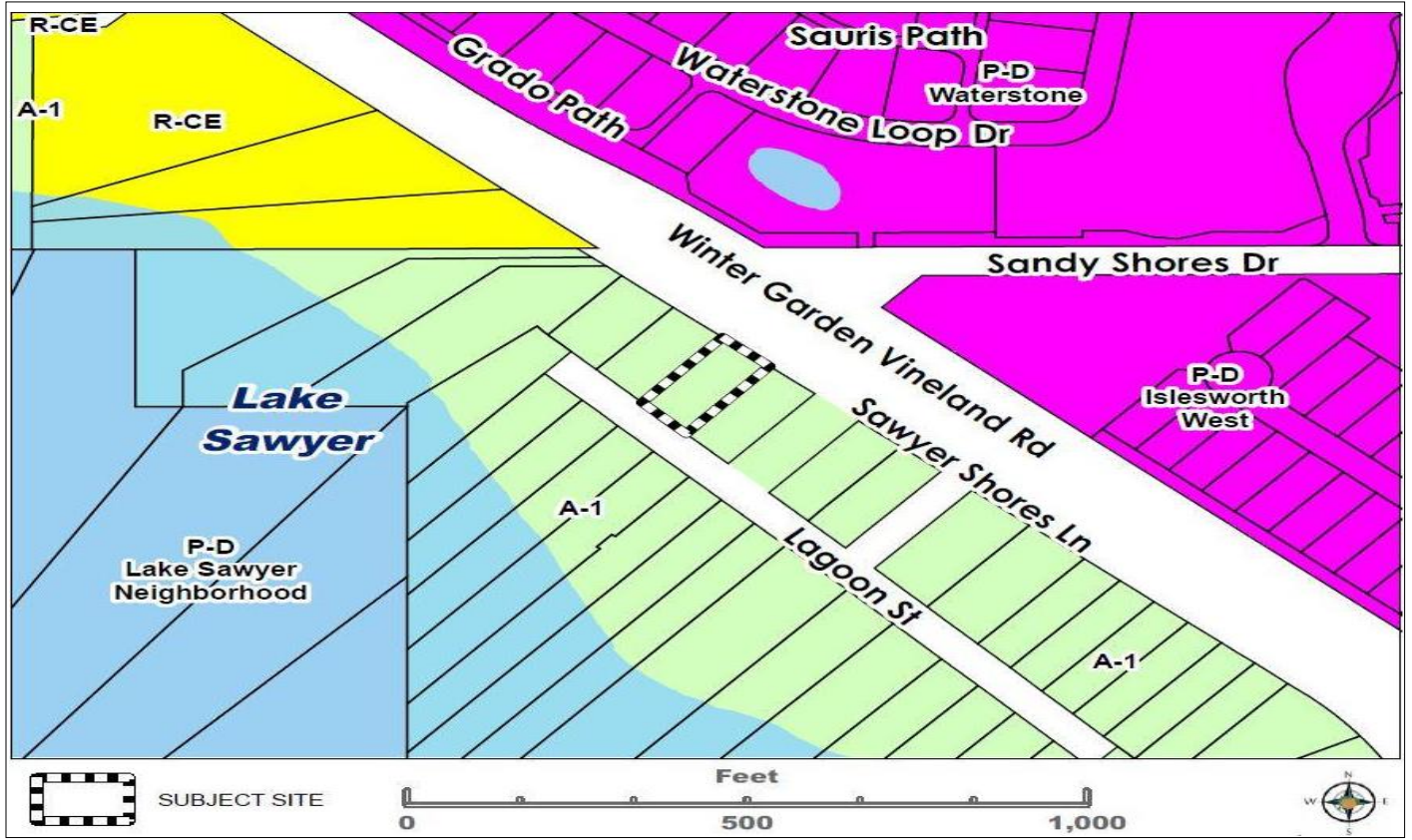
5. **Minimum Possible Variance** - The zoning variance approved is the minimum variance that will make possible the reasonable use of the land, building, or structure.

The minimum possible variance is all I am asking.

6. **Purpose and Intent** - Approval of the zoning variance will be in harmony with the purpose and intent of the Zoning Regulations and such zoning variance will not be injurious to the neighborhood or otherwise detrimental to the public welfare.

The shed has been on the property since 2006 and has had no negative impact on my property, the property of the adjacent neighbor or the neighborhood in general.

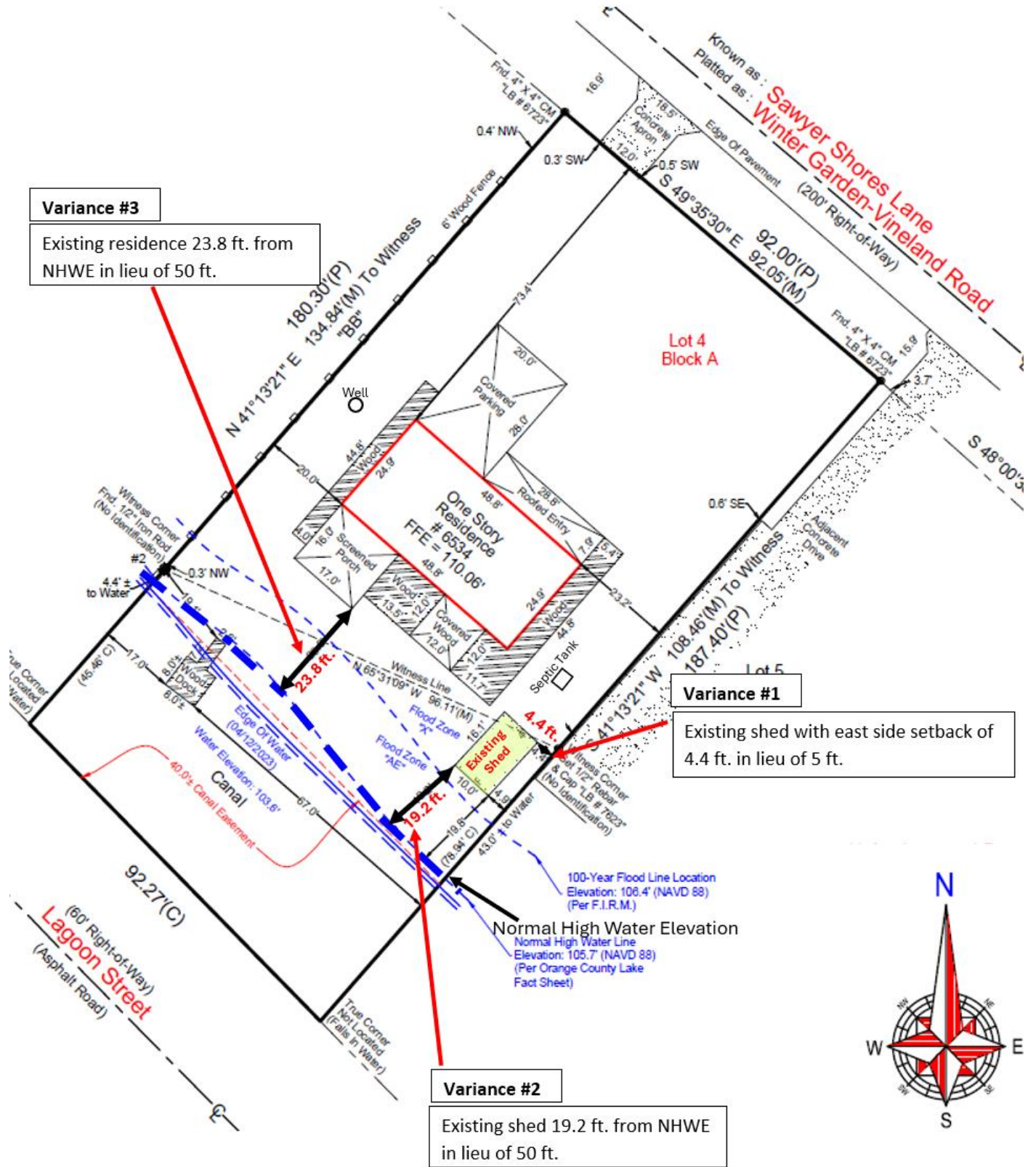
ZONING MAP



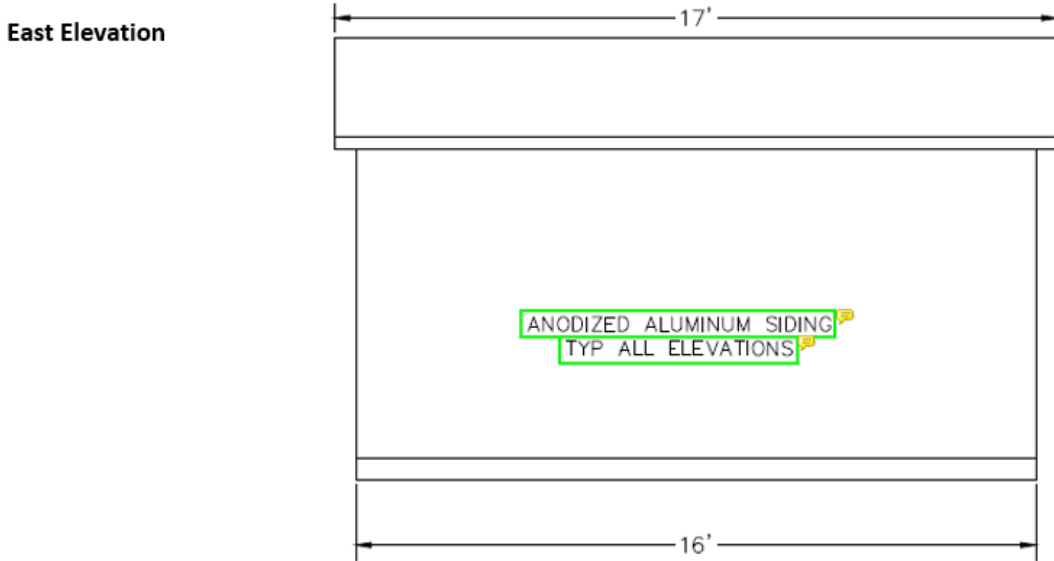
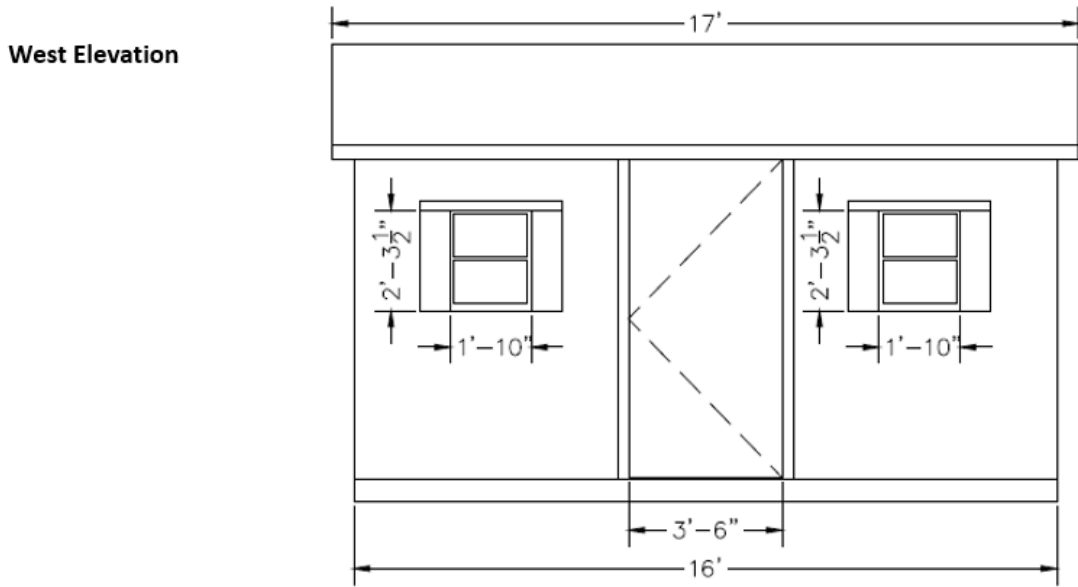
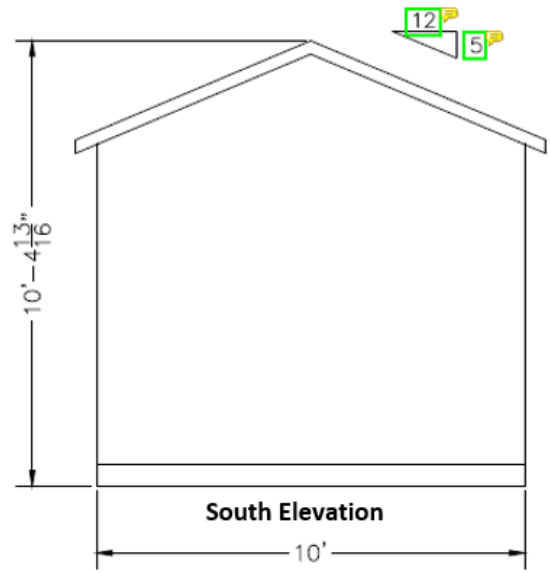
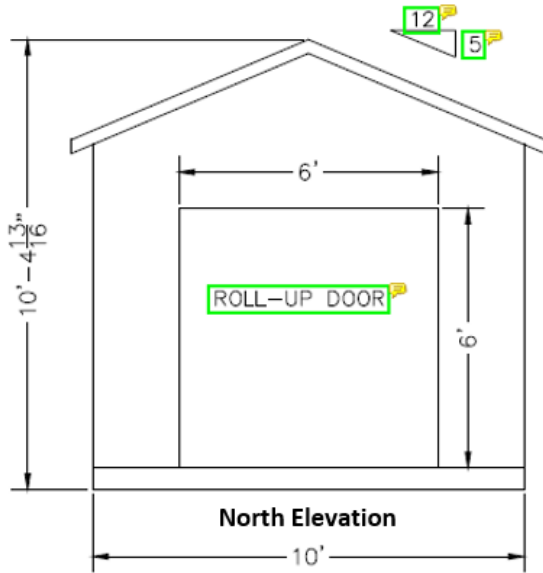
AERIAL MAP



**SURVEY**



ELEVATIONS FOR EXISTING SHED





---

**SITE PHOTOS**

---



**Facing south from Sawyer Shores Ln. towards subject property**



**Front yard, facing south towards front of existing residence and carport improvement**

**SITE PHOTOS**



**Side yard, facing west towards existing well location**



**Rear yard, facing northwest towards existing rear of residence**

**SITE PHOTOS**



**Side yard, facing southeast towards existing accessory structure**



**Side yard, facing southeast towards Variance #1 request**

**SITE PHOTOS**



**Rear yard, facing south towards canal**



**Facing north from Lagoon Ave. towards subject property**



**BOARD OF ZONING ADJUSTMENT**  
**201 S. Rosalind Ave.**  
**Orlando, FL 32801**